

# Mult iDome International

## SCHWIMMBECKENÜBERDACHUNGEN KLASIK "C"

Mult iDome  
International

## SCHWIMMBADÜBERDACHUNGEN

Typ C



VERLÄNGERT  
DIE BADESAISON  
MARKANT



ERWÄRMT DAS WASSER  
IM SWIMMINGPOOL  
GRATIS



SCHÜTZT IHRE KINDER  
VOR DEM ERTRINKEN



VERHINDERT DIE  
WASSERVERSCHMUTZUNG



## MONTAGEANLEITUNG

# typ KLASIK C

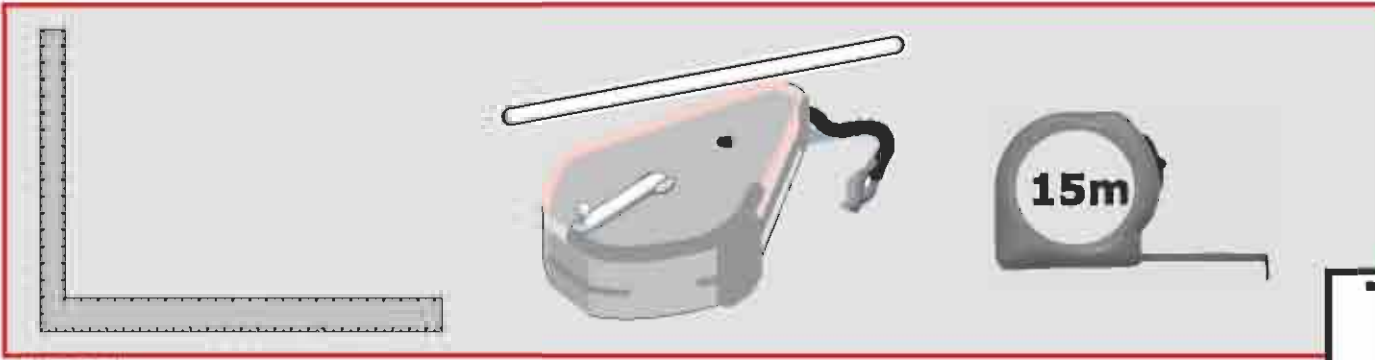
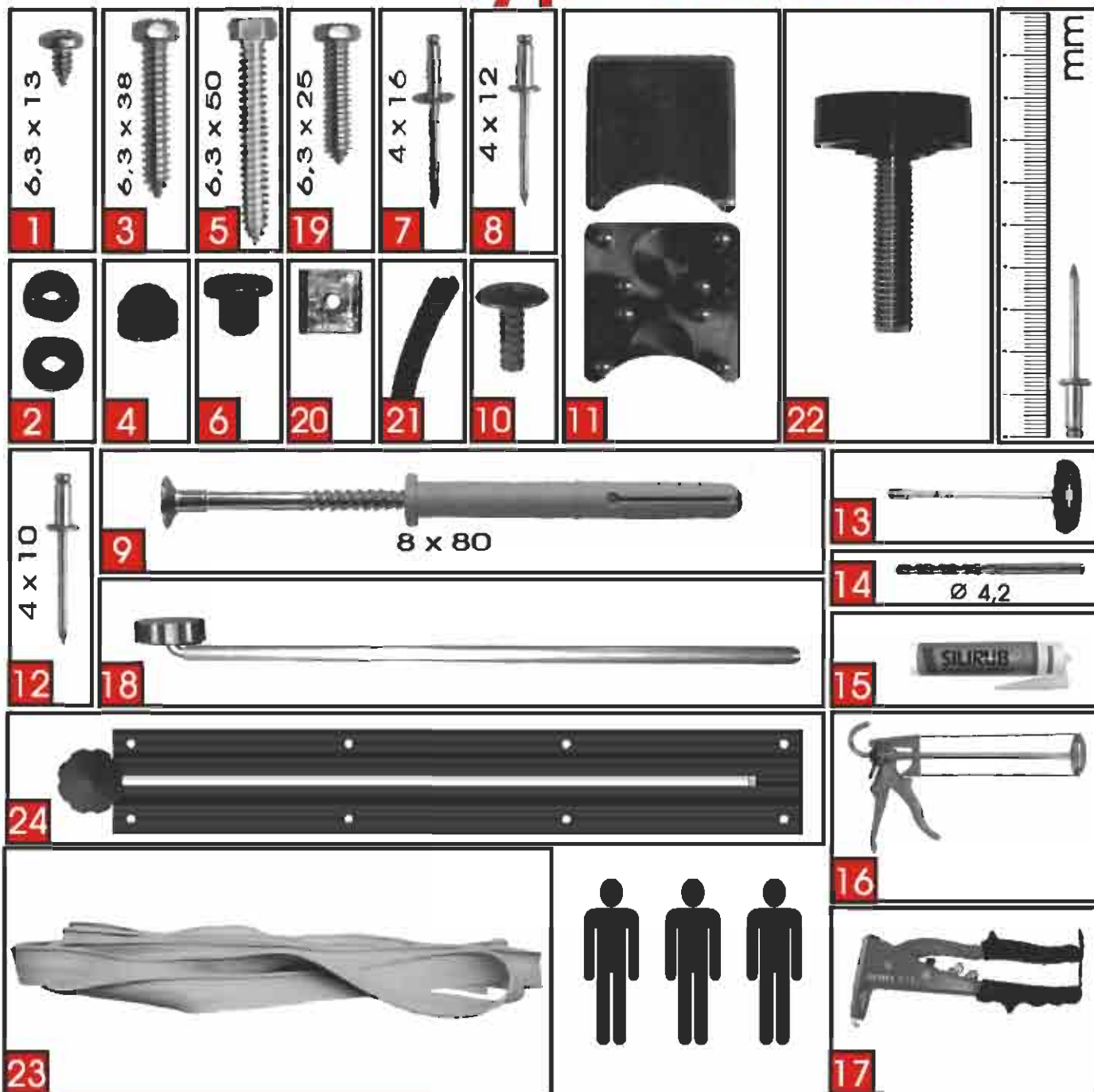

# typ KLASIK C

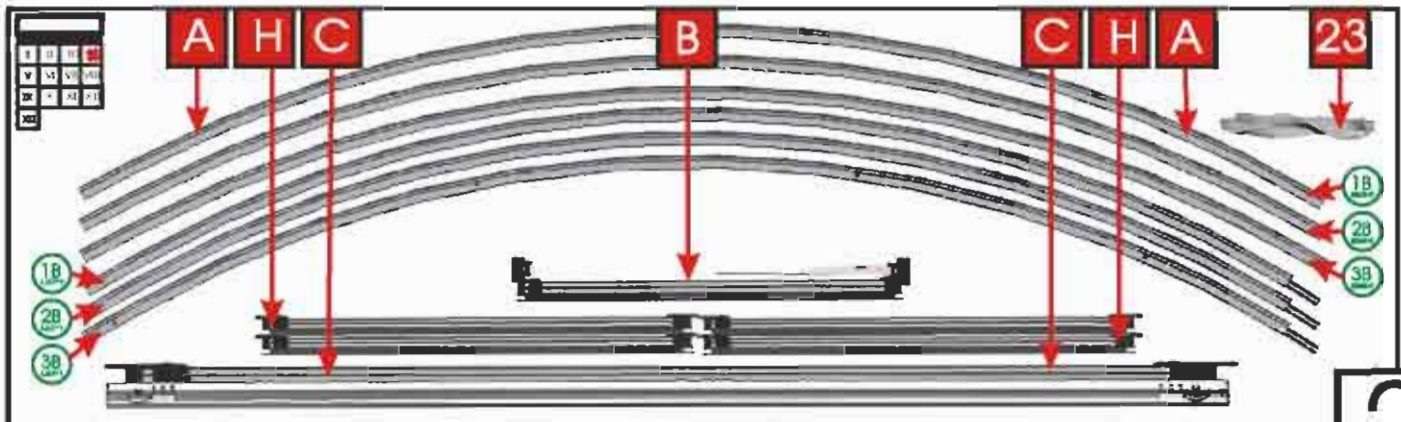
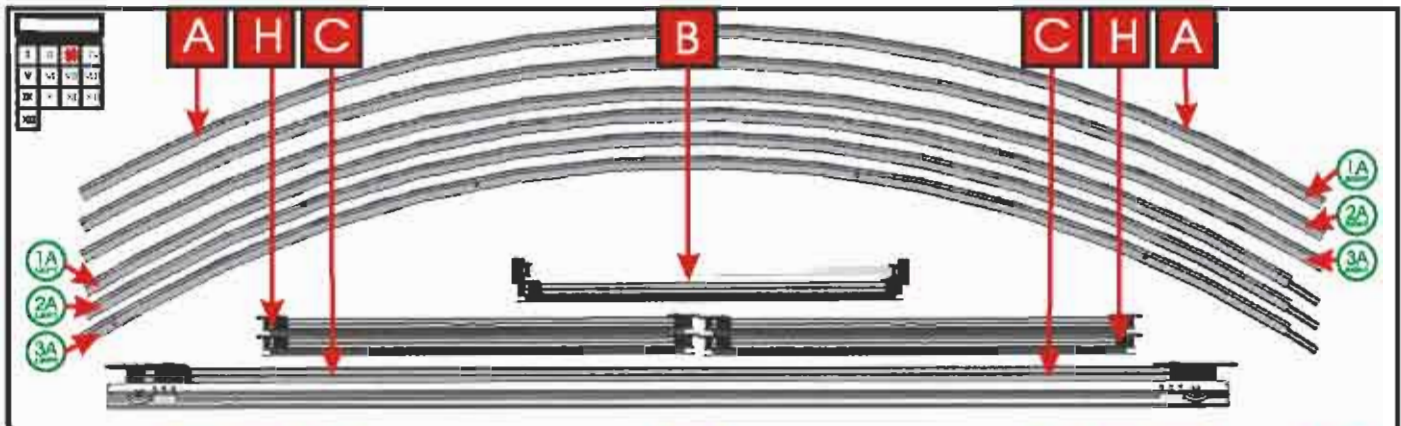
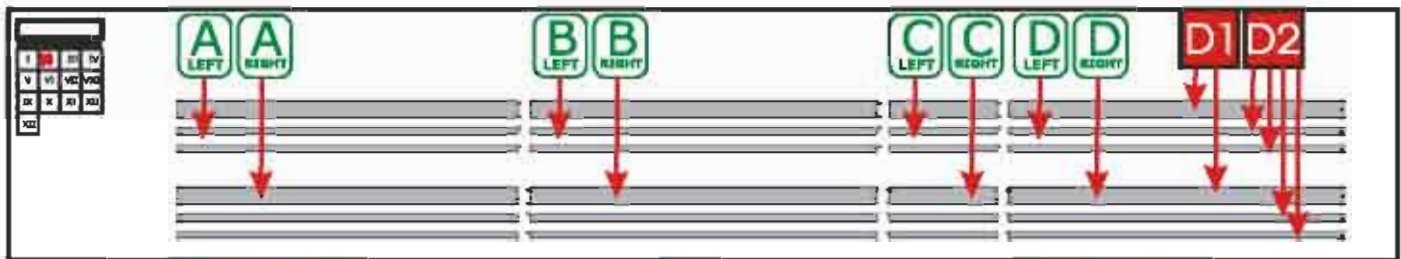

# typ KLASIK C

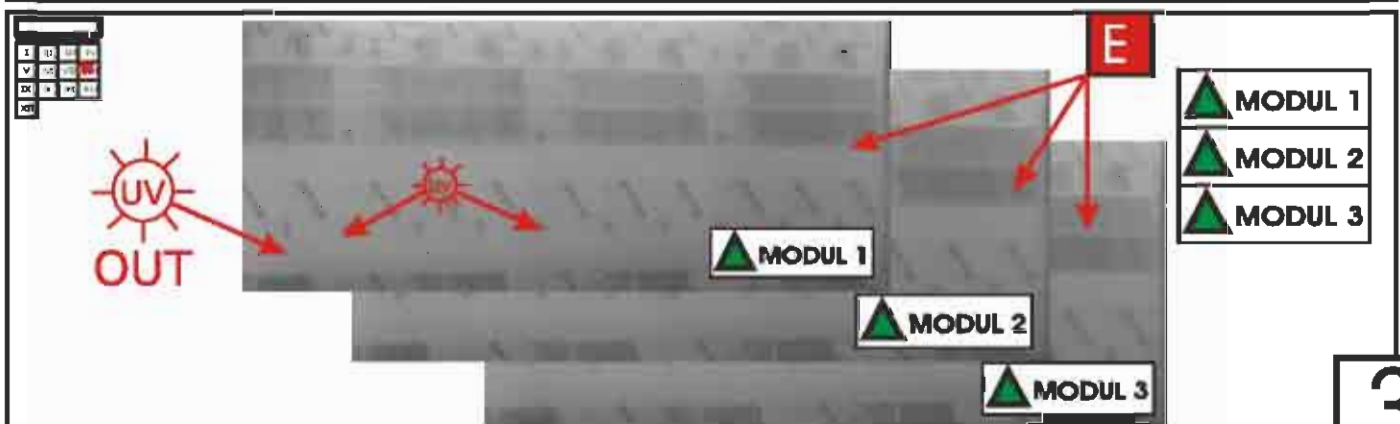
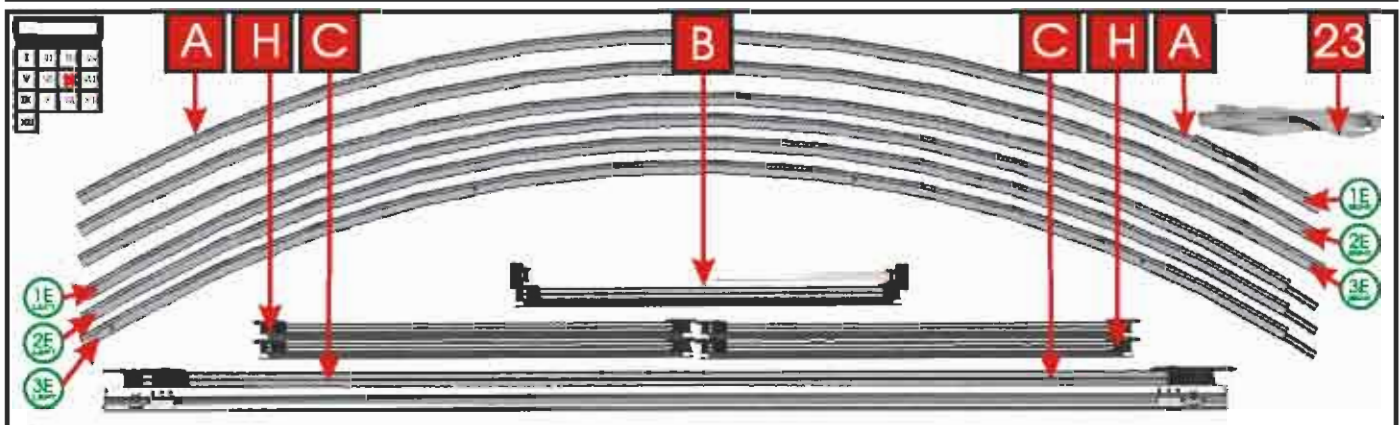
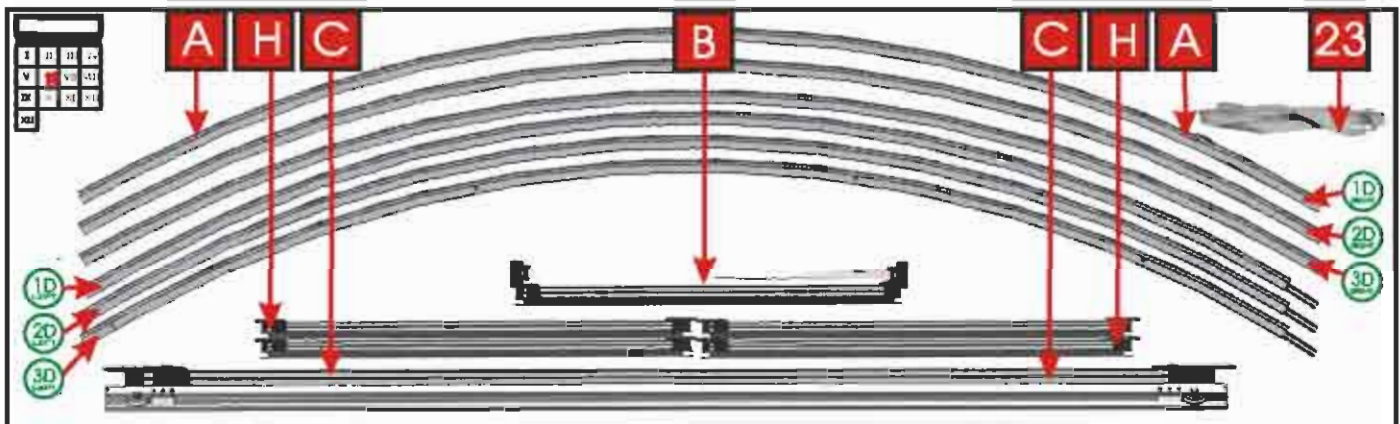
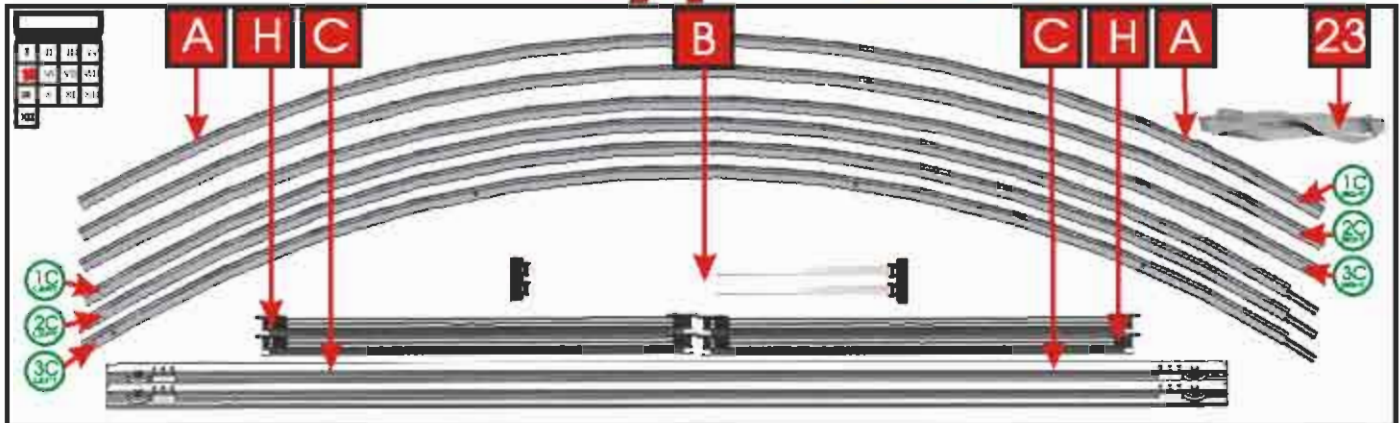

# typ KLASIK C

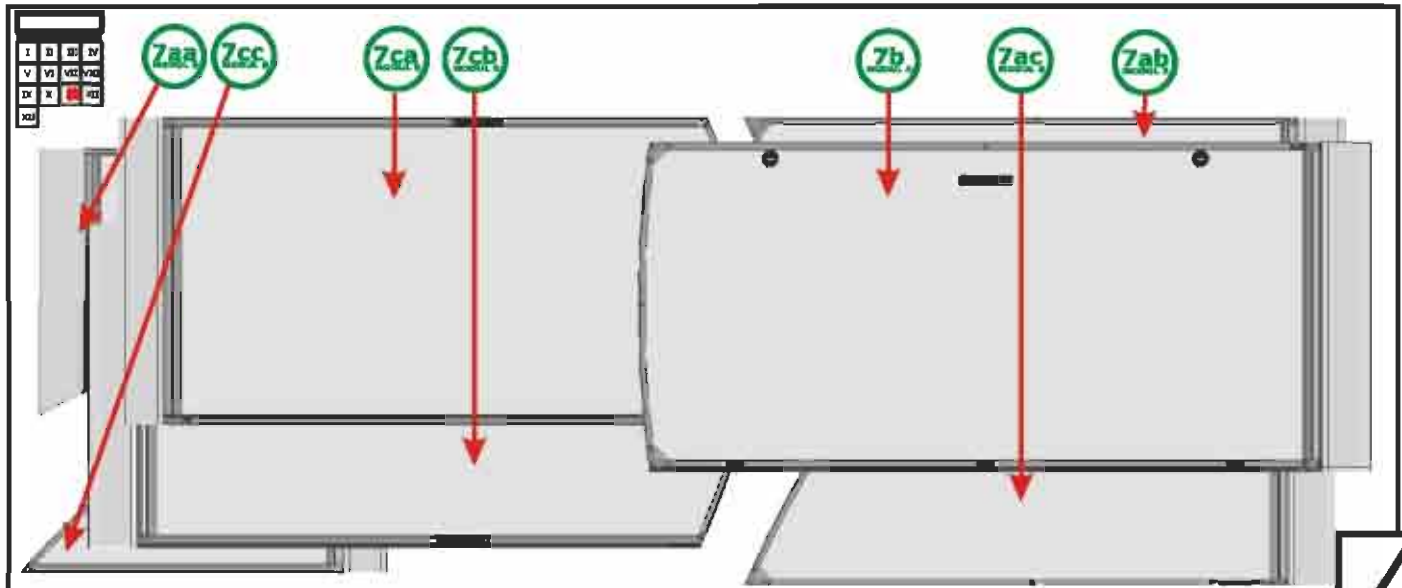
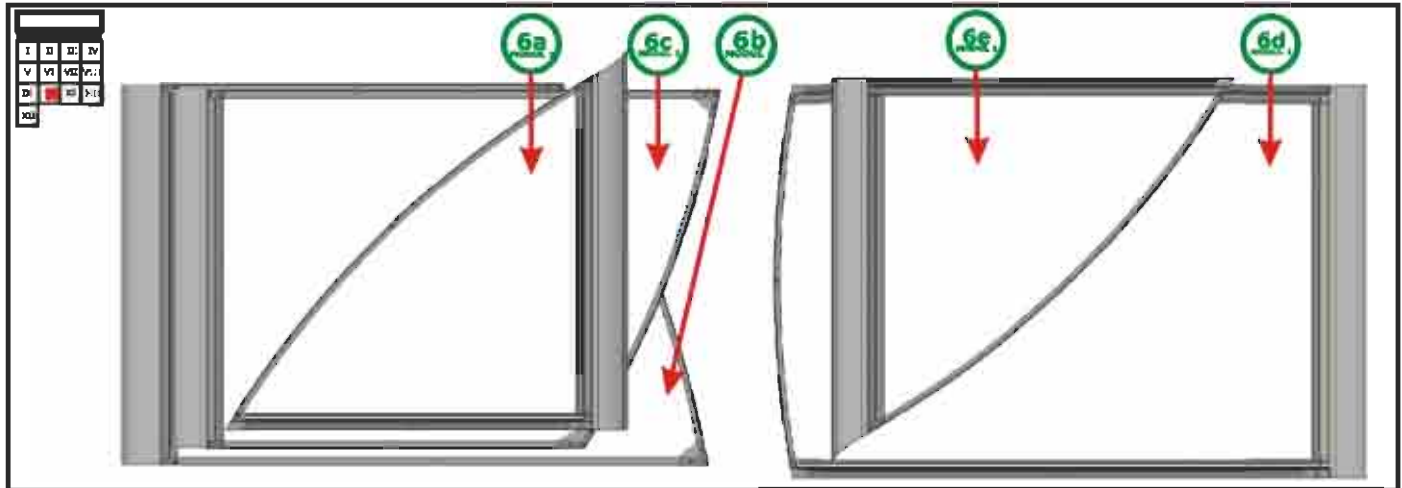
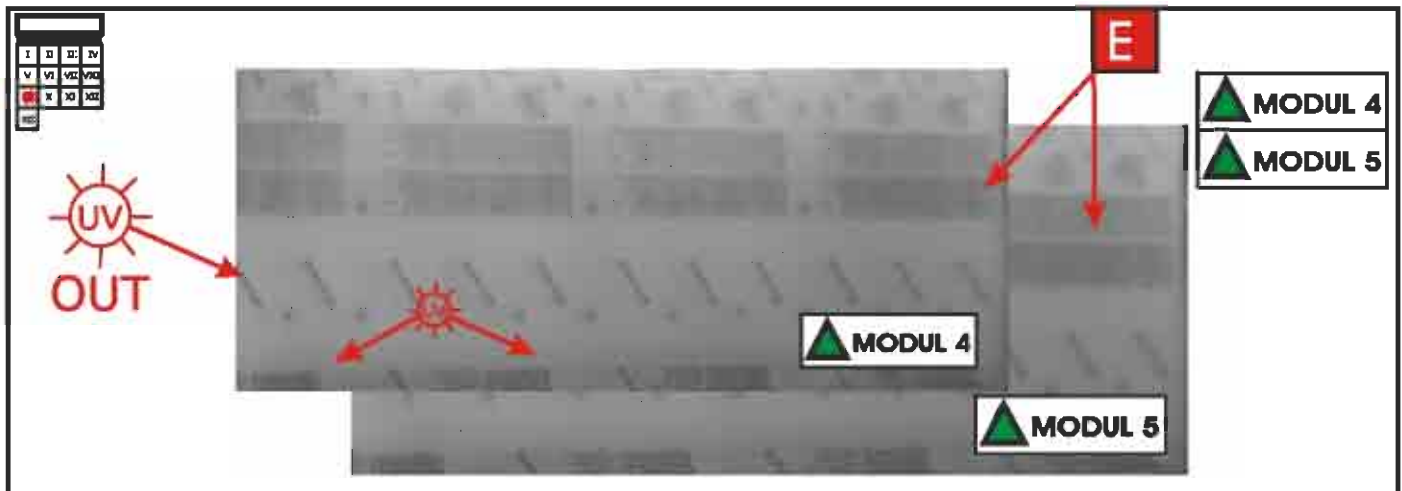

# typ KLASIK C

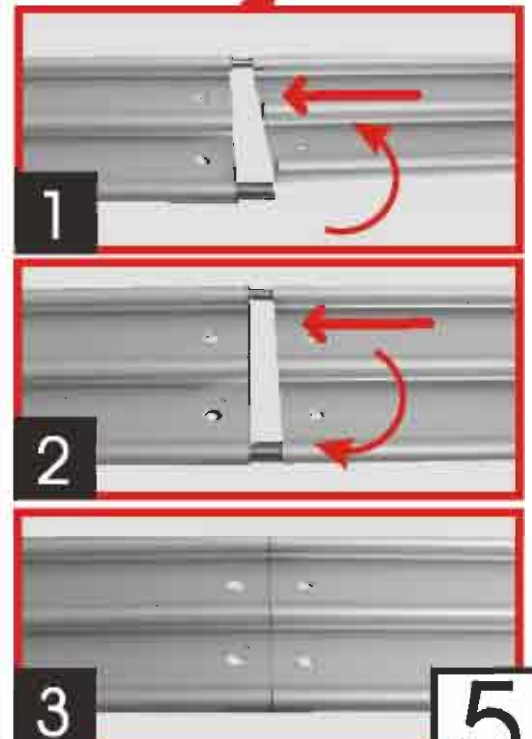
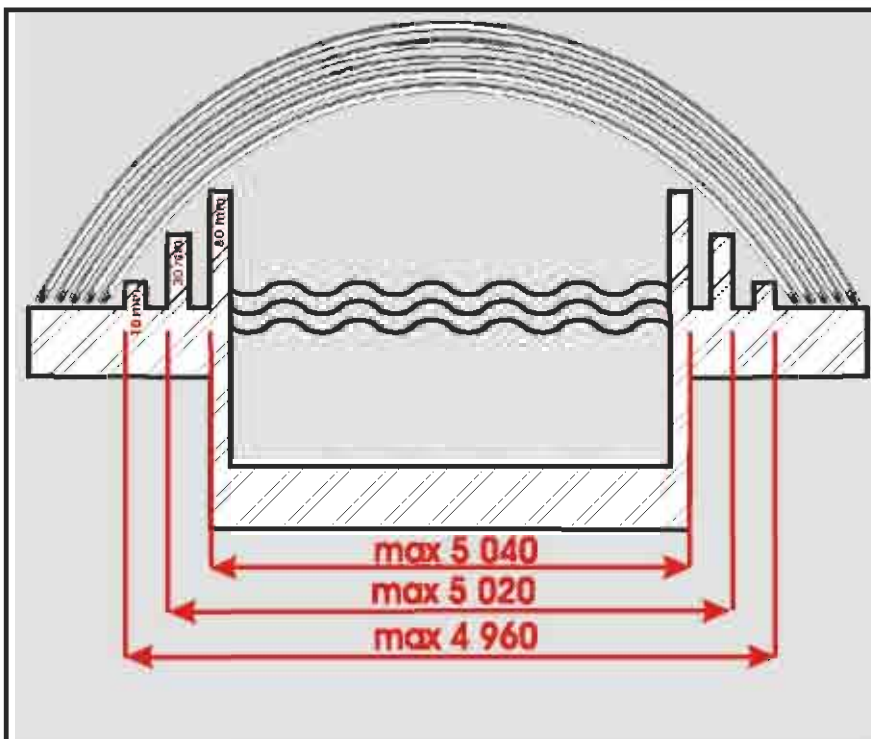
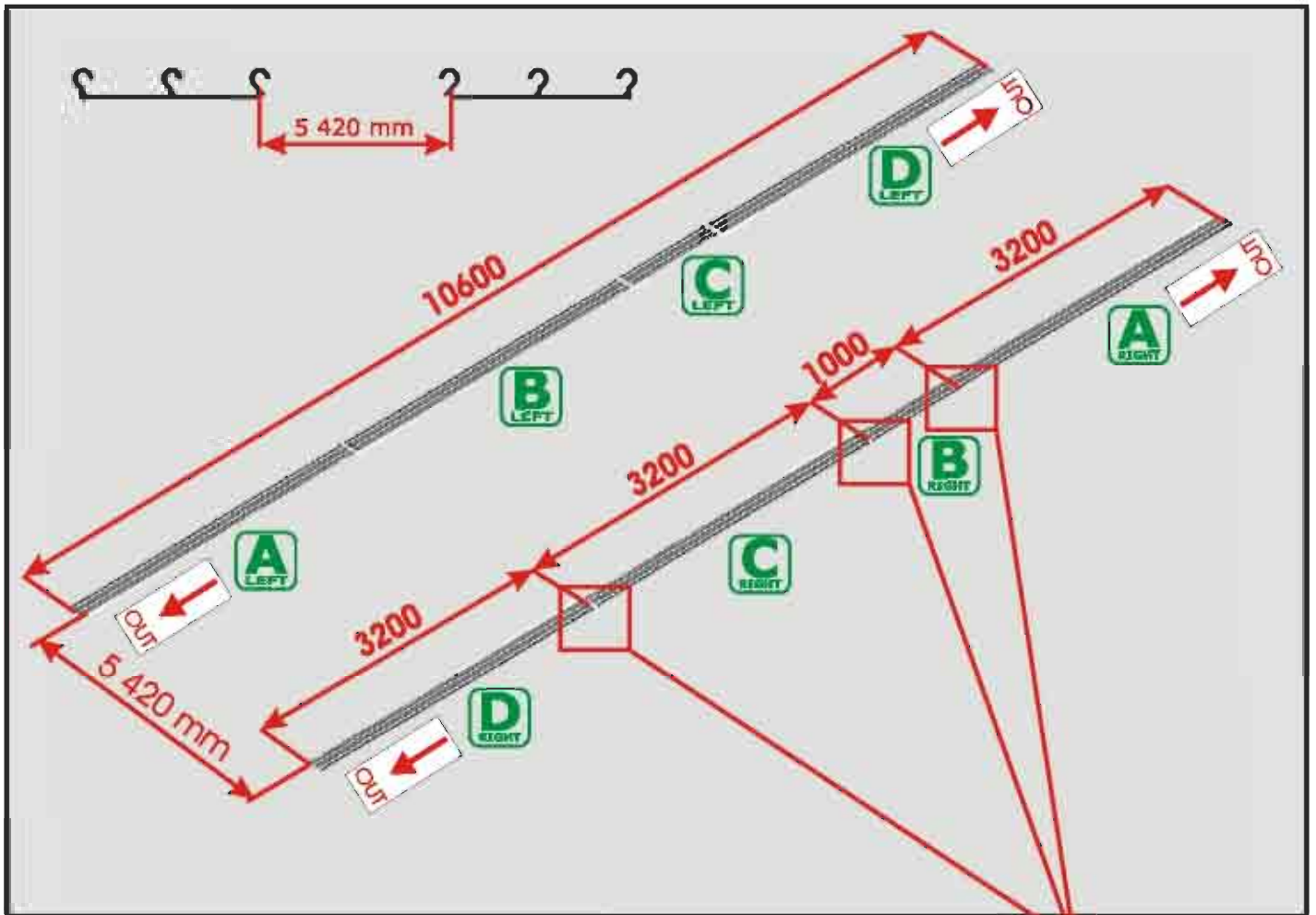

# typ KLASIK C

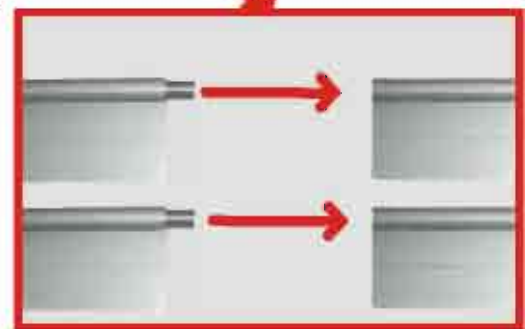
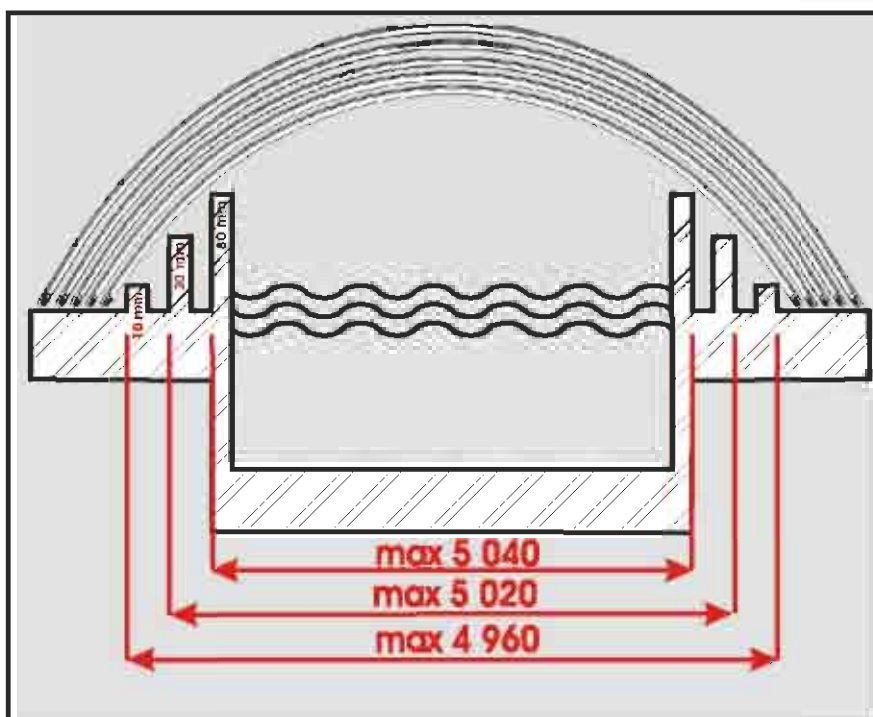
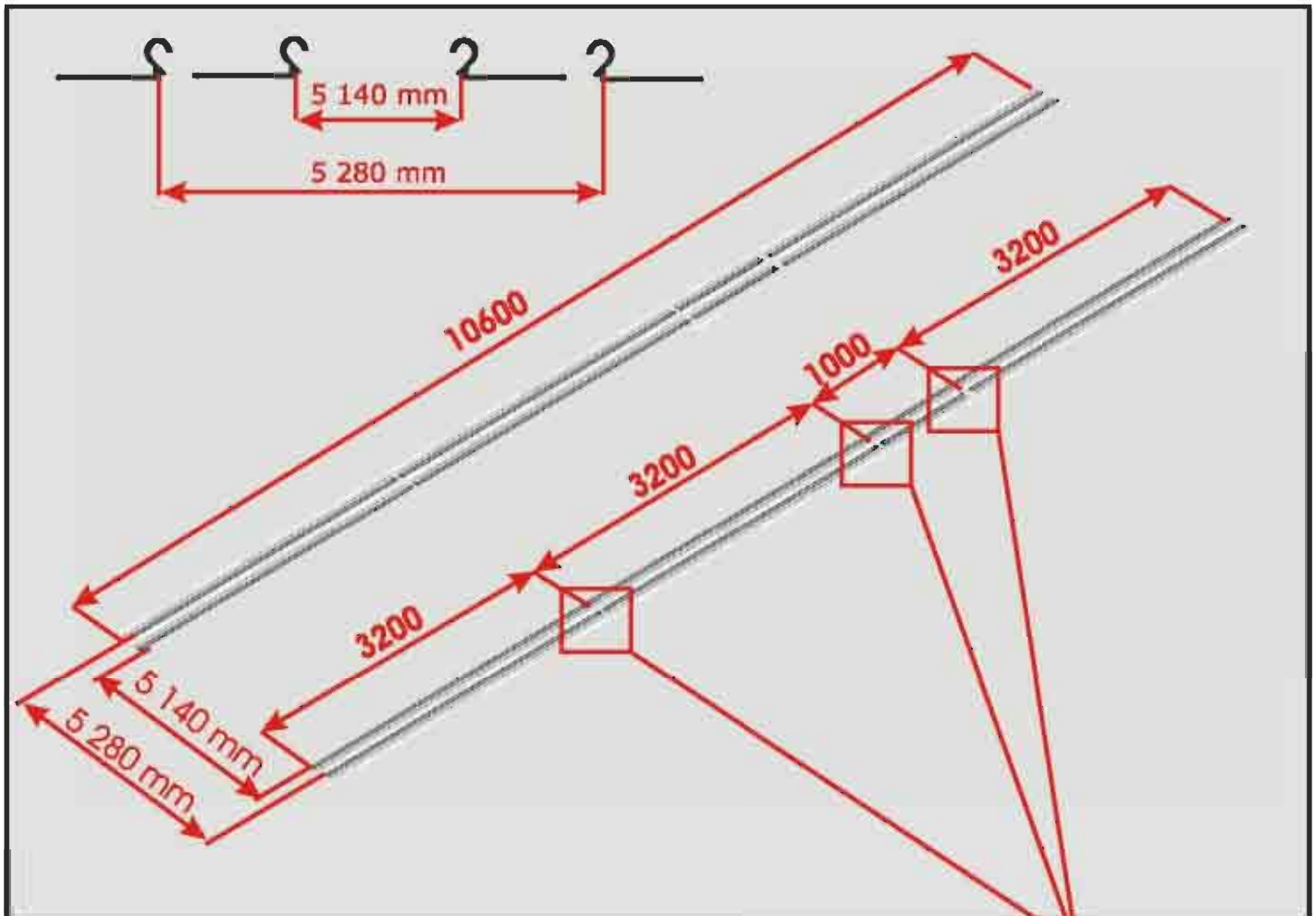

# typ KLASIK C

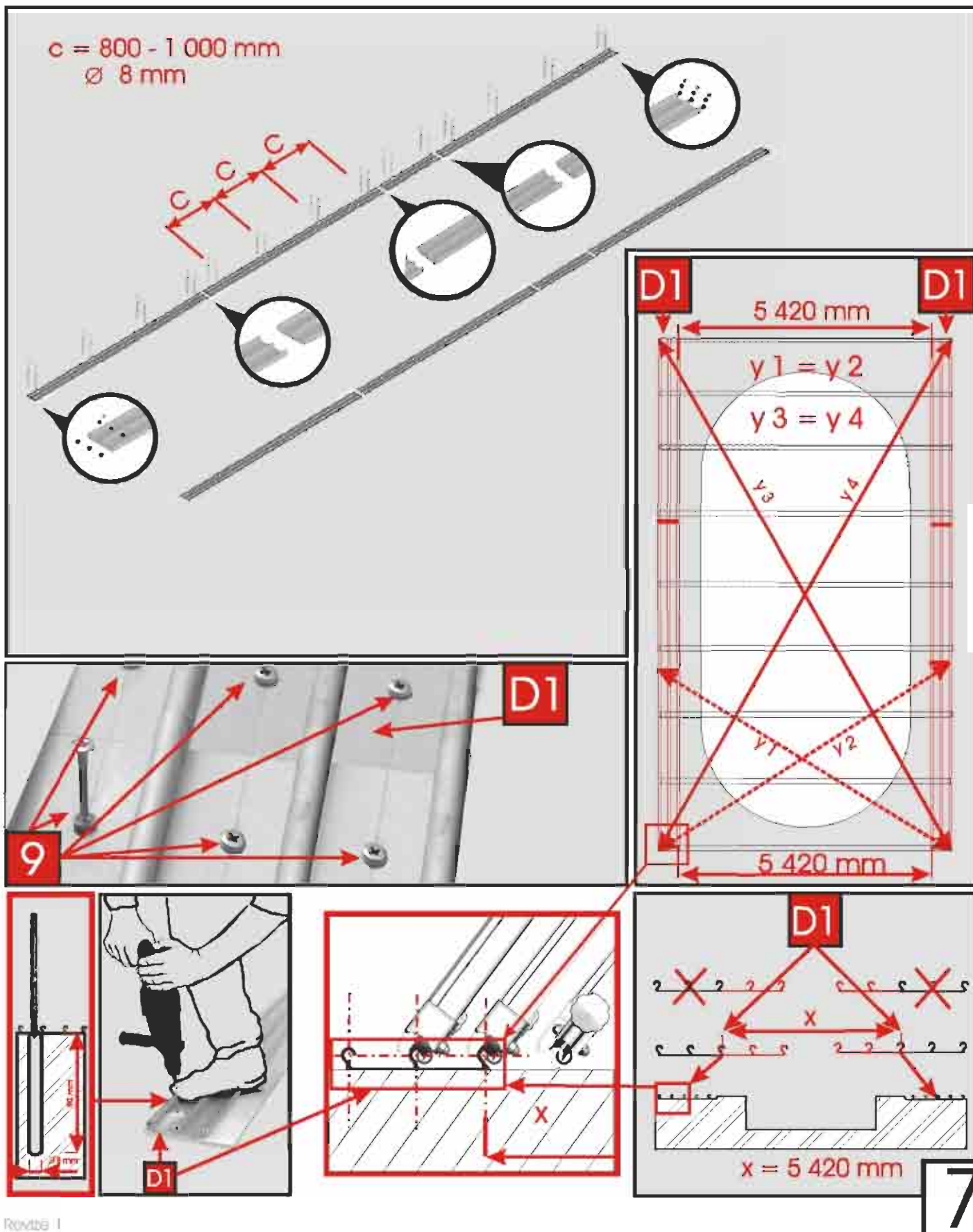



# typ KLASIK C

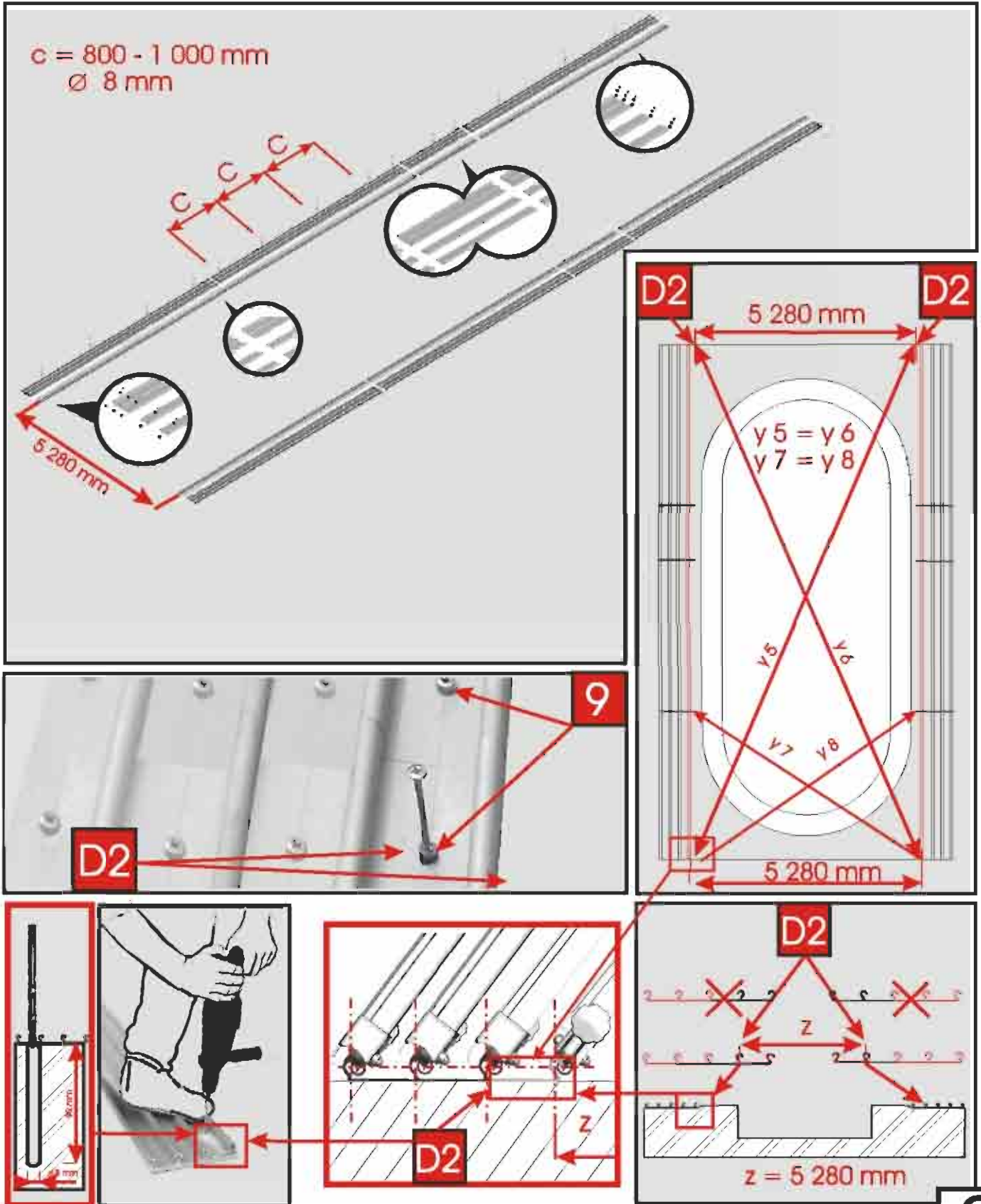

# typ KLASIK C

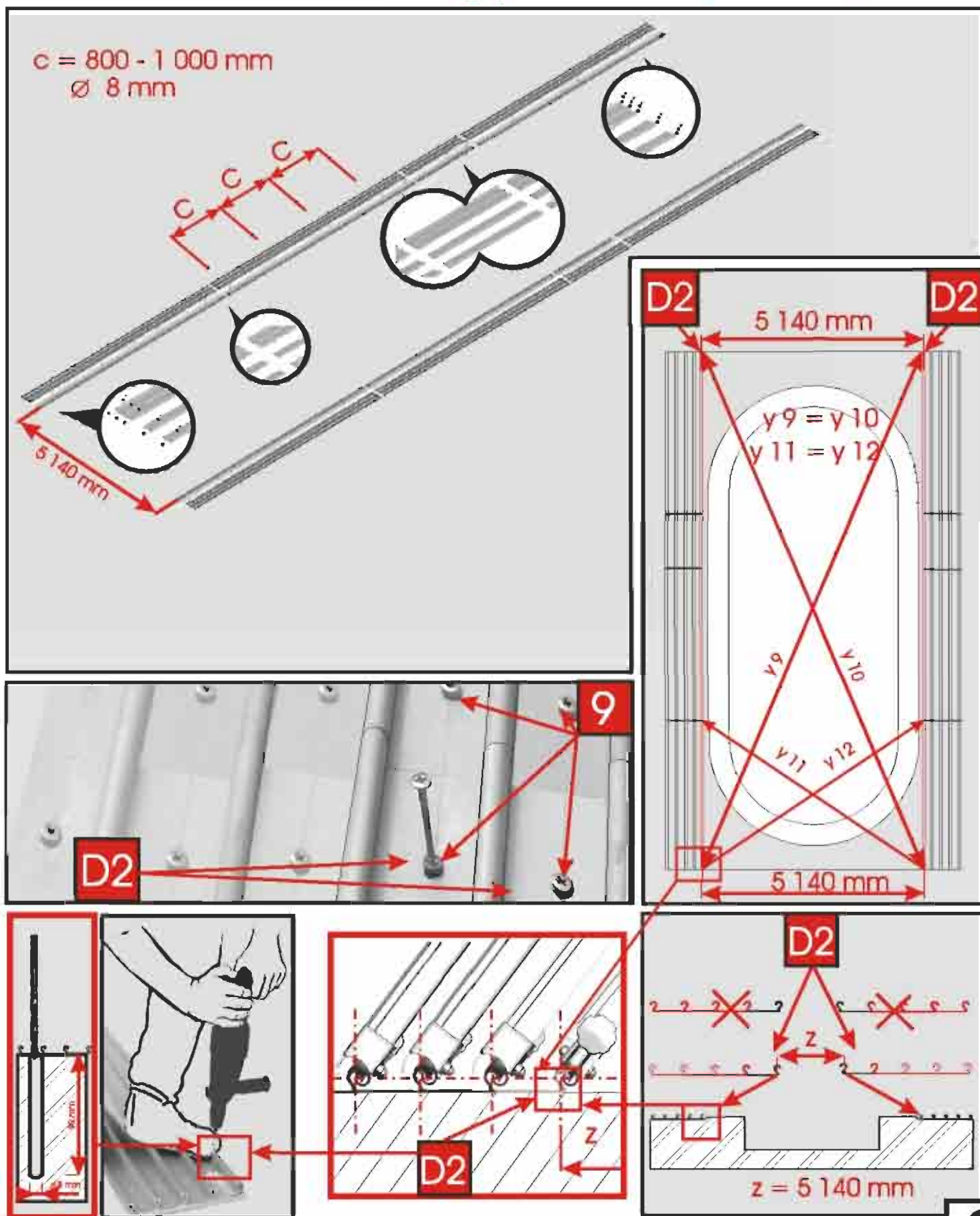

typ KLASIK C  
modul 1

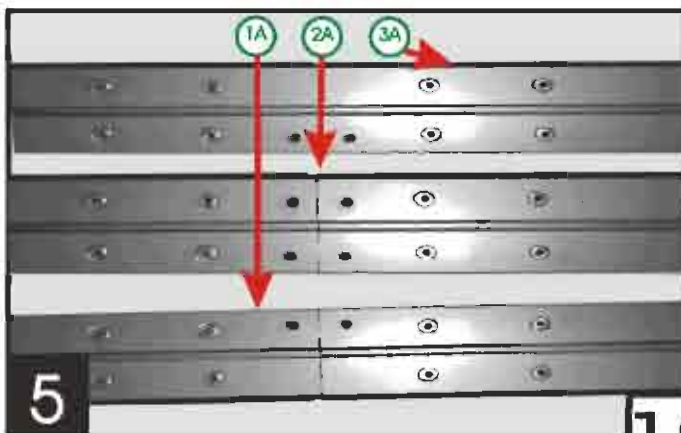
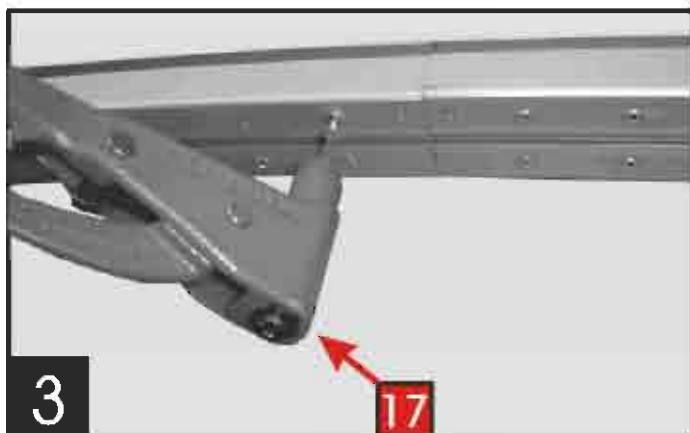
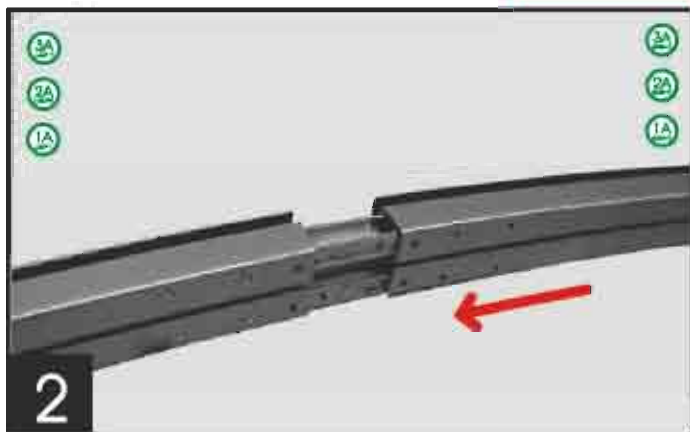
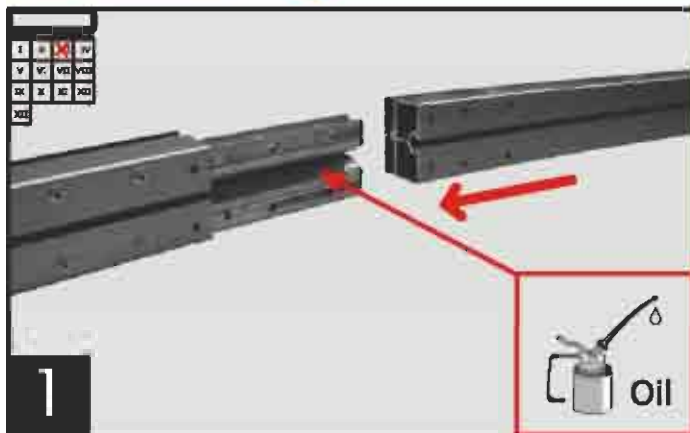
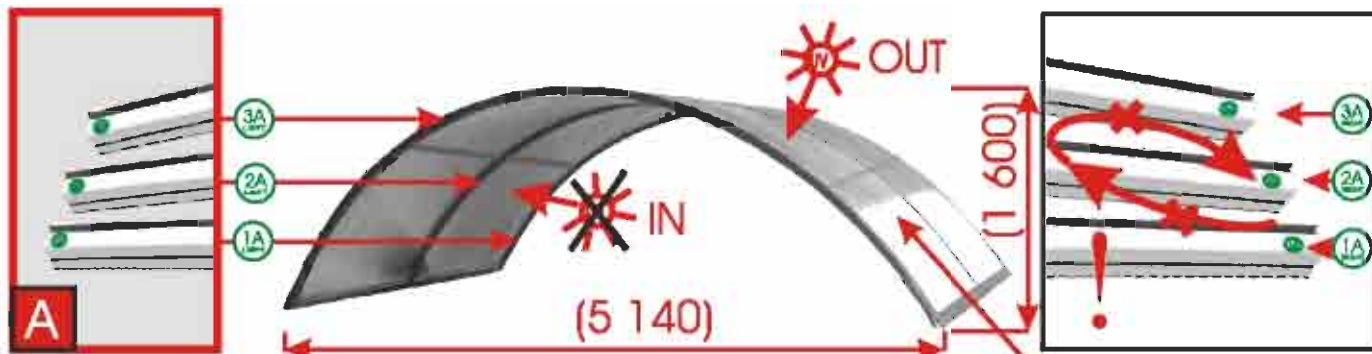

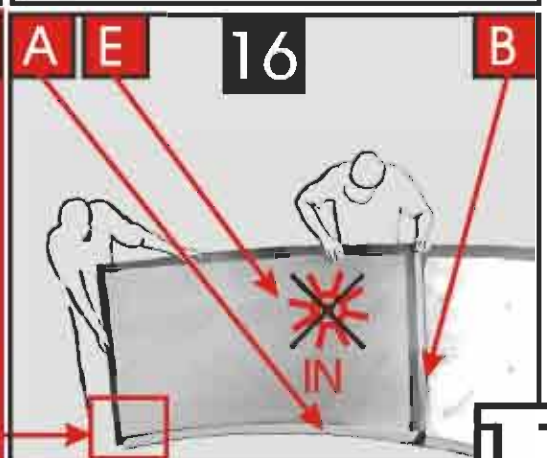
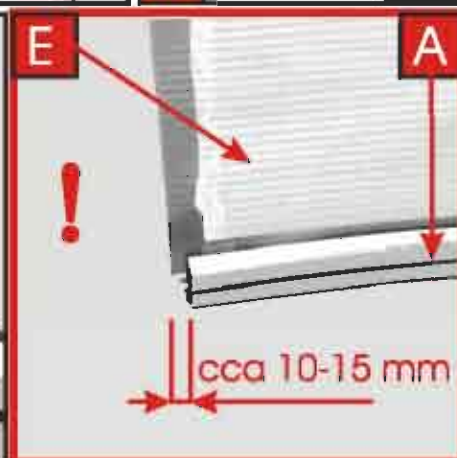
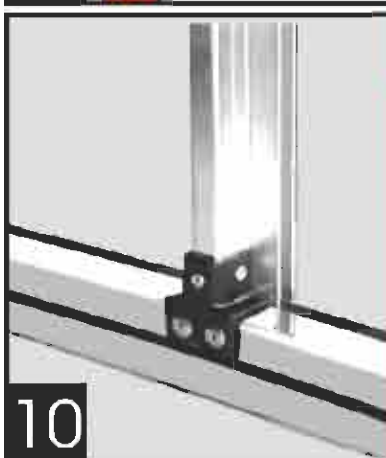
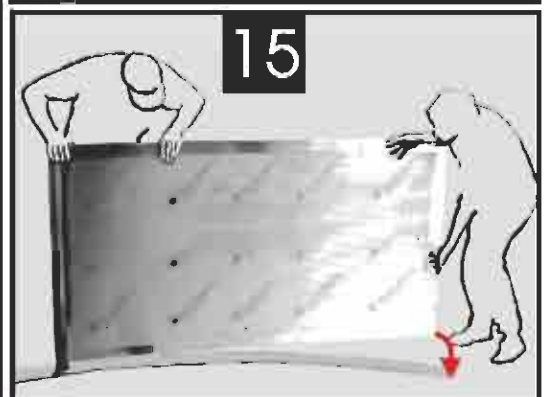
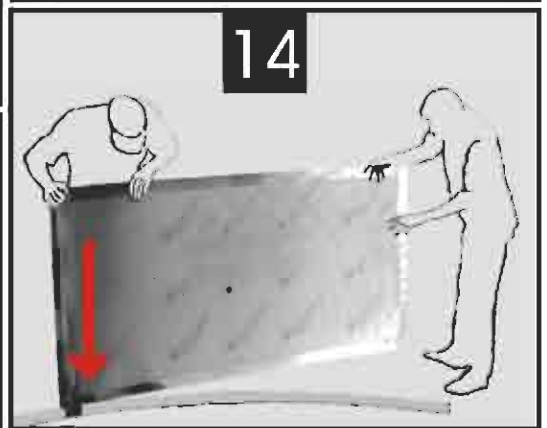
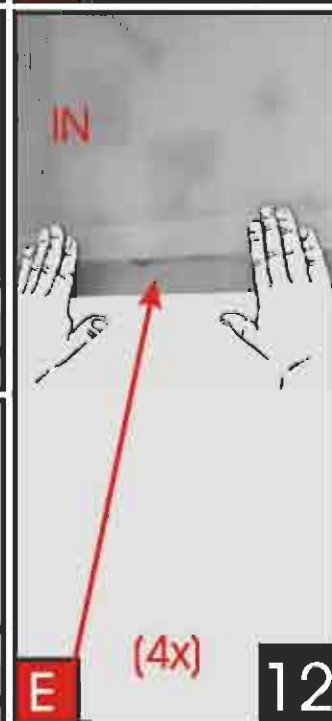
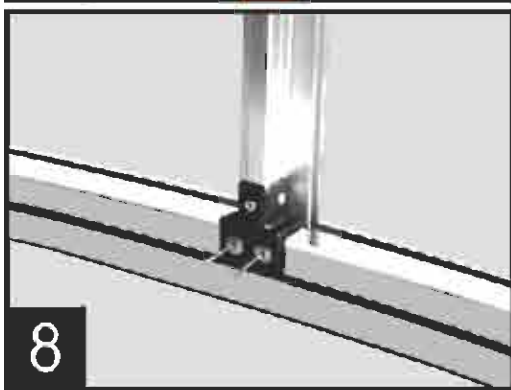
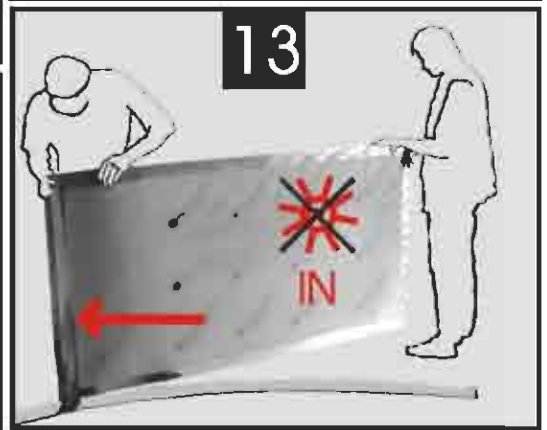
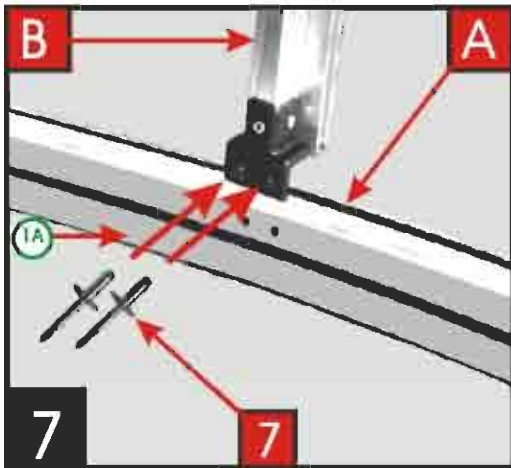
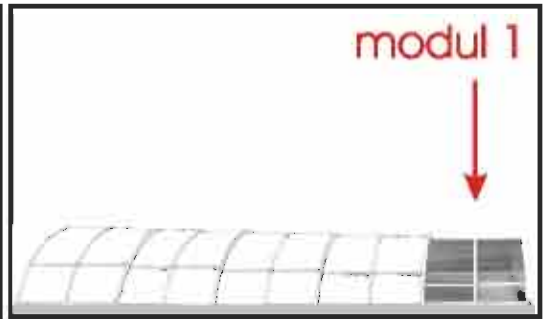
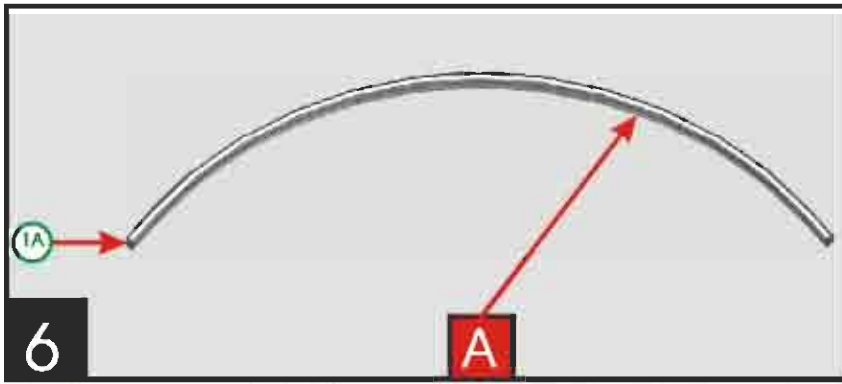

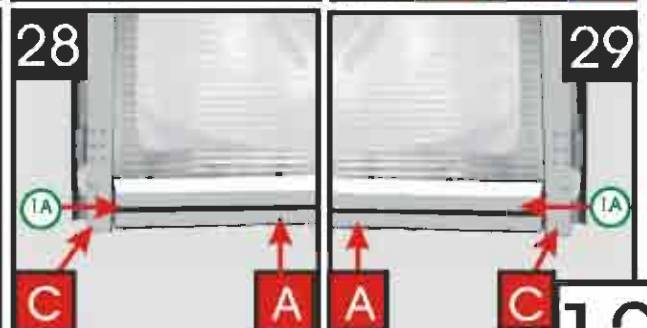
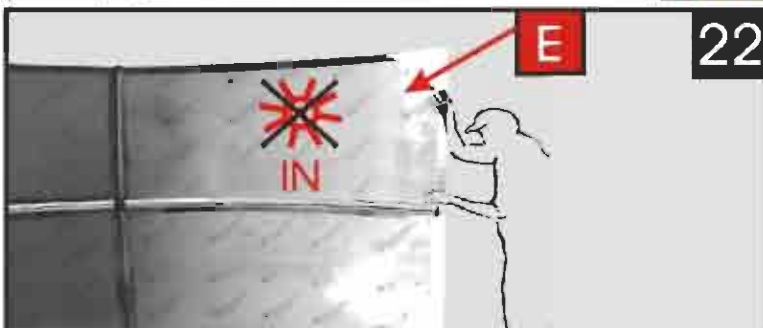
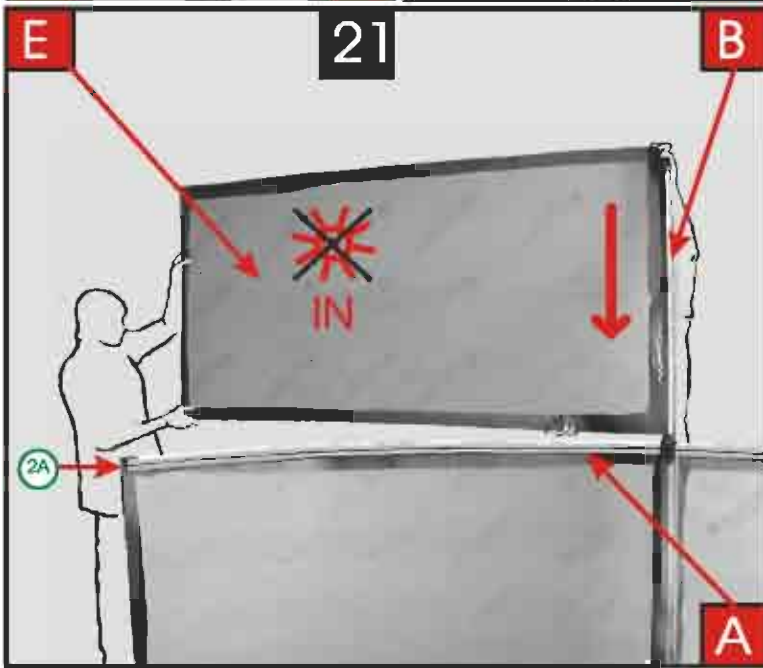
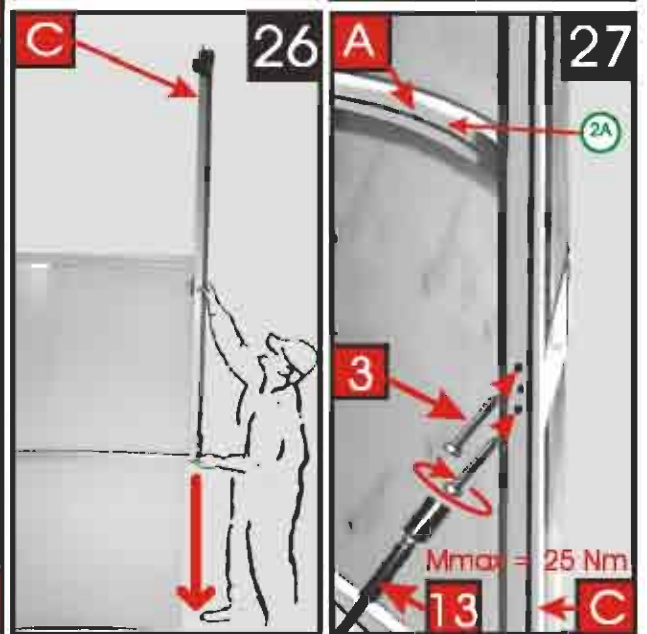
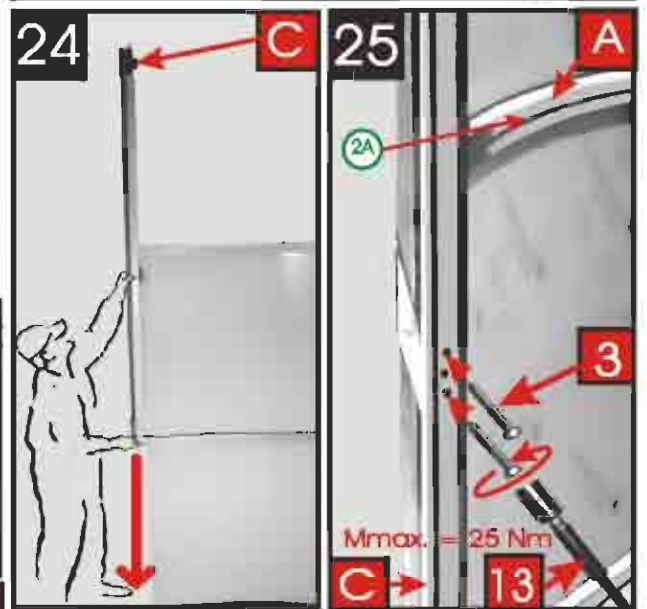
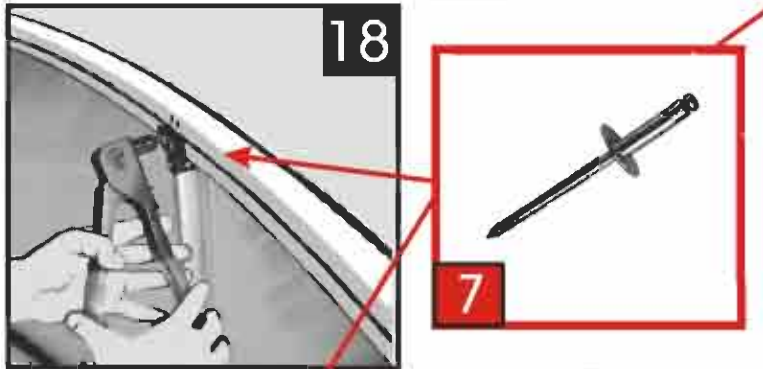
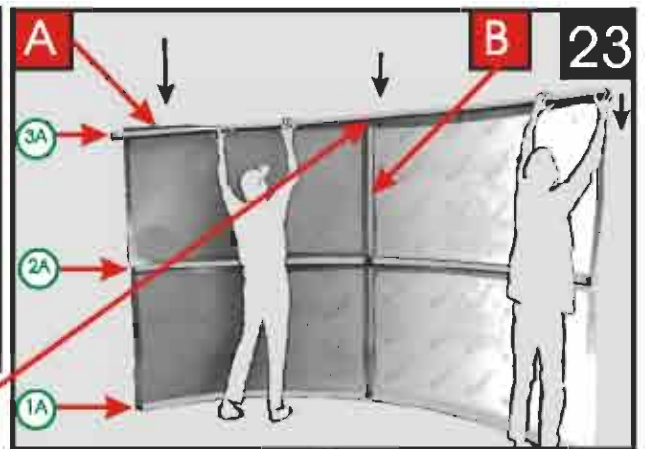
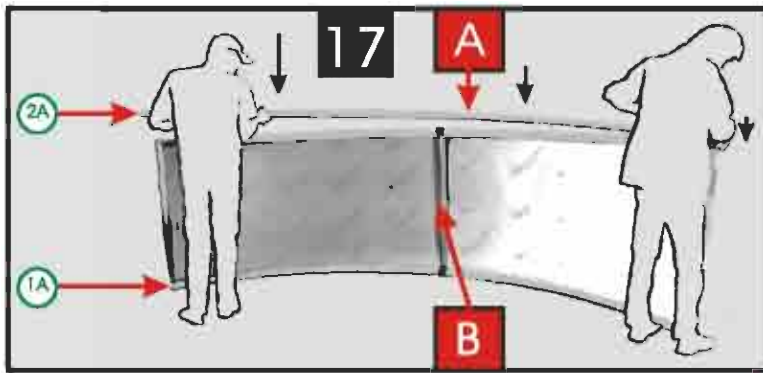

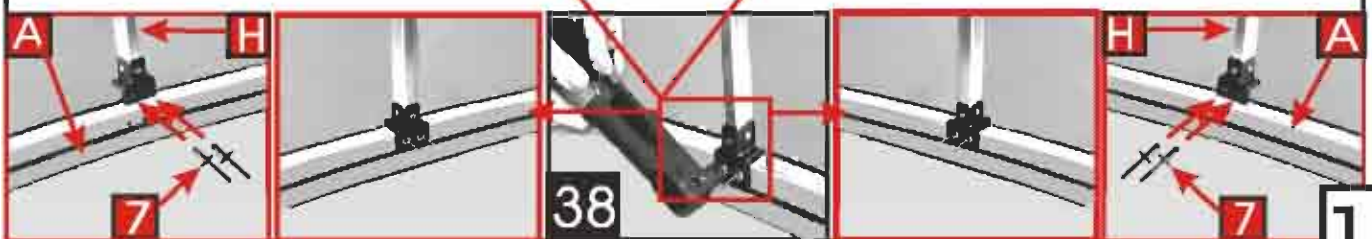
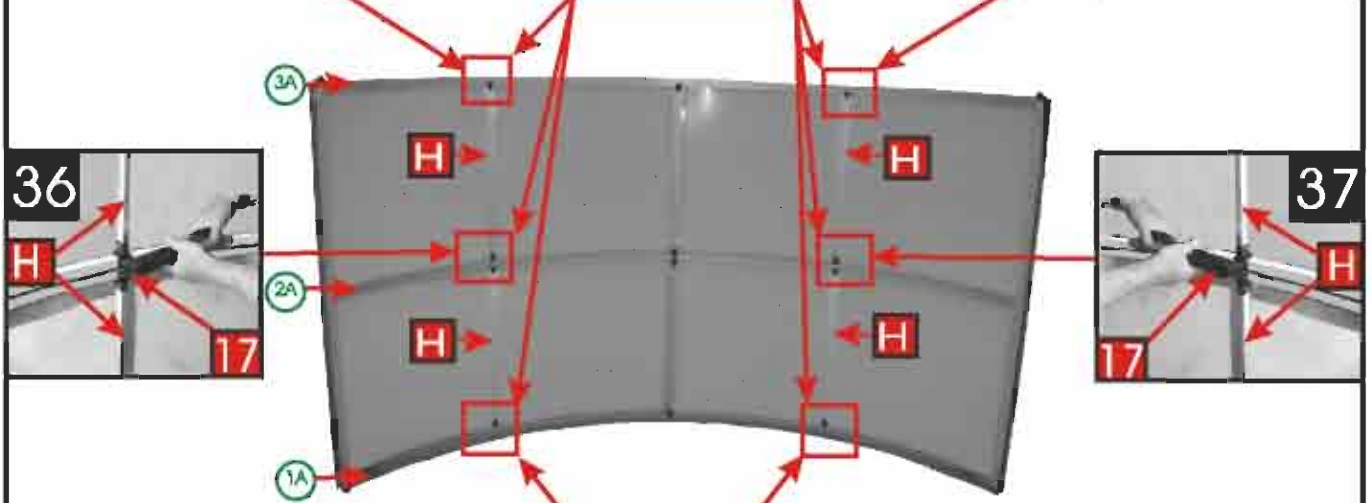
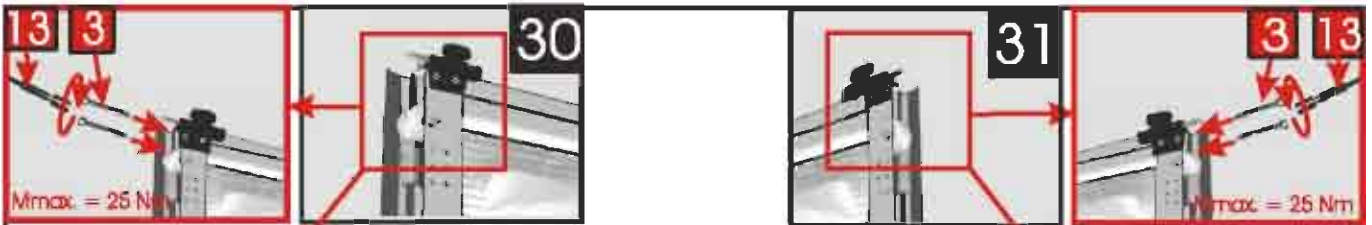

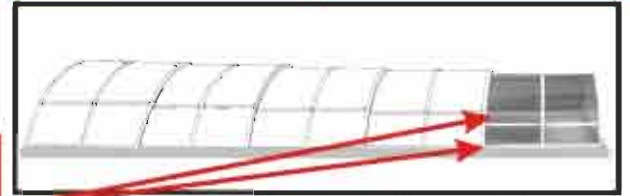
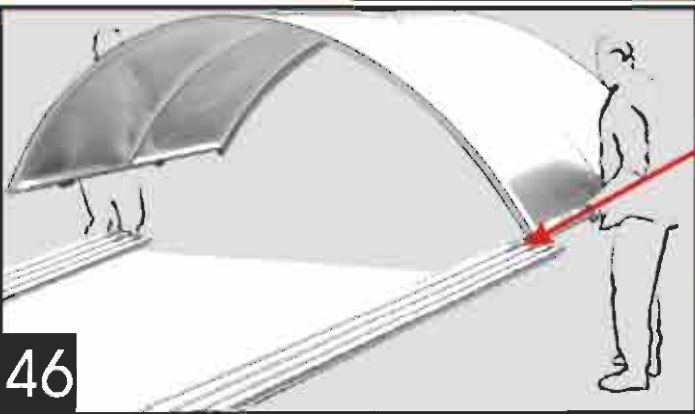
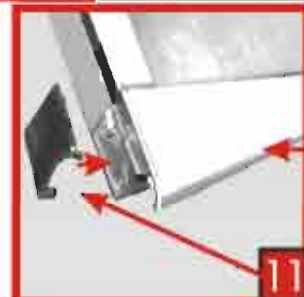
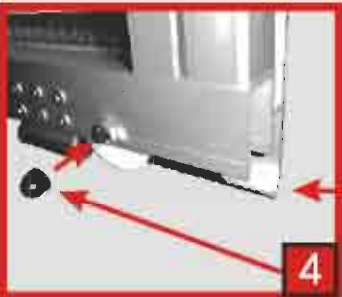
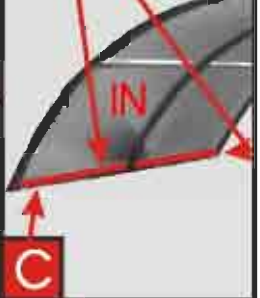
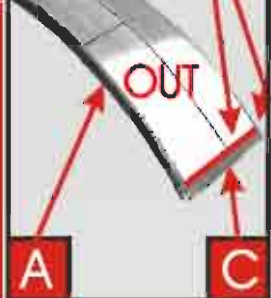
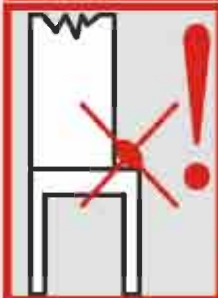
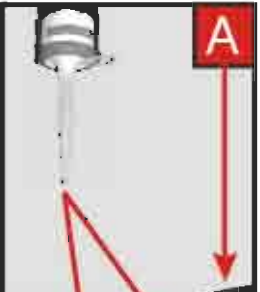
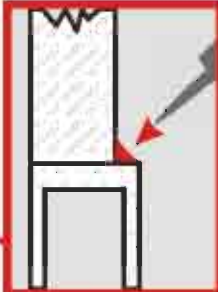
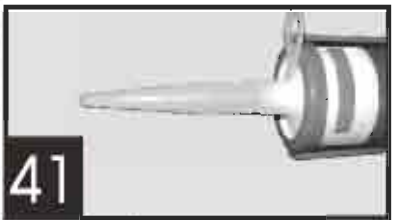

typ KLASIK C  
modul 2

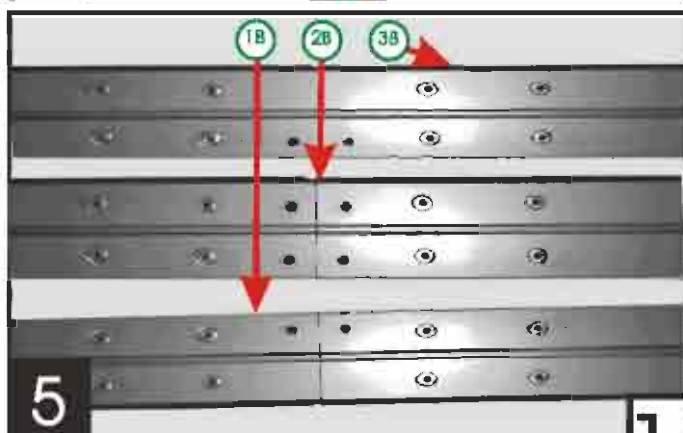
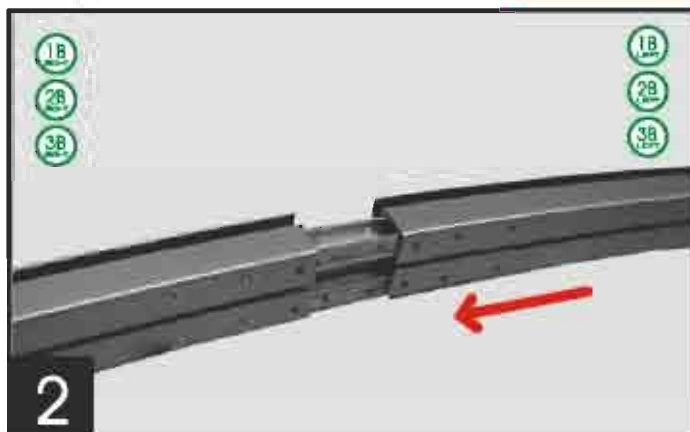
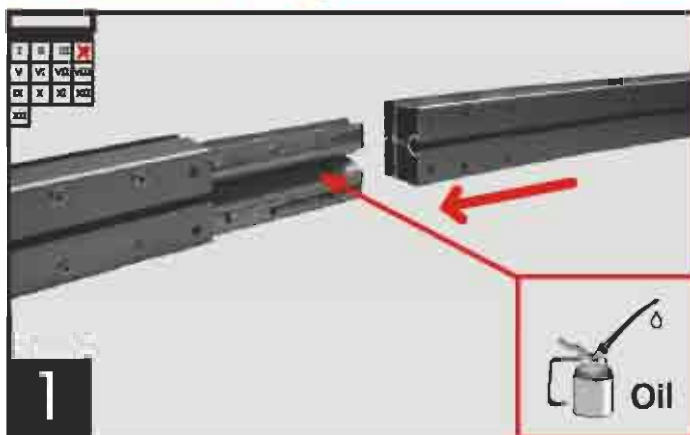
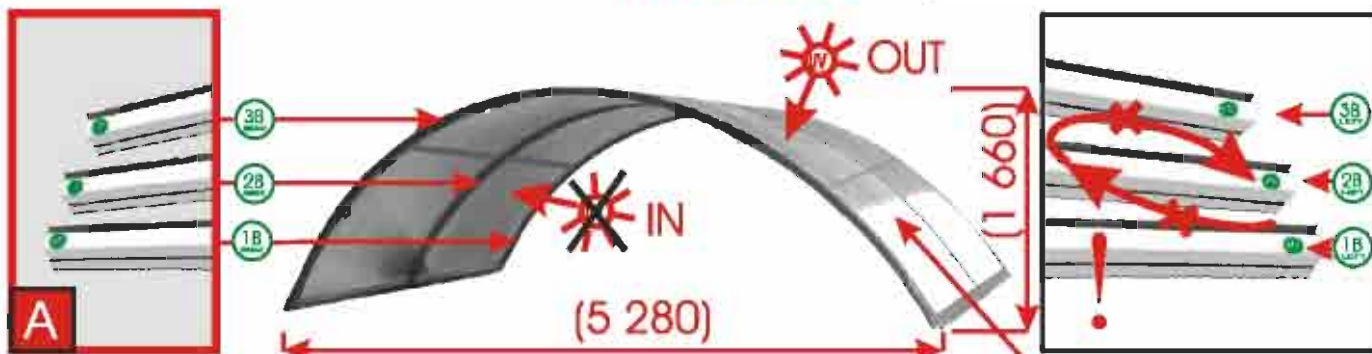



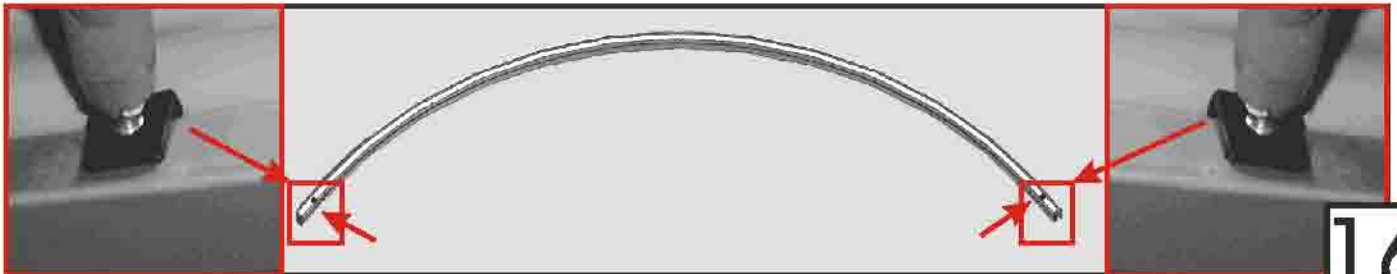
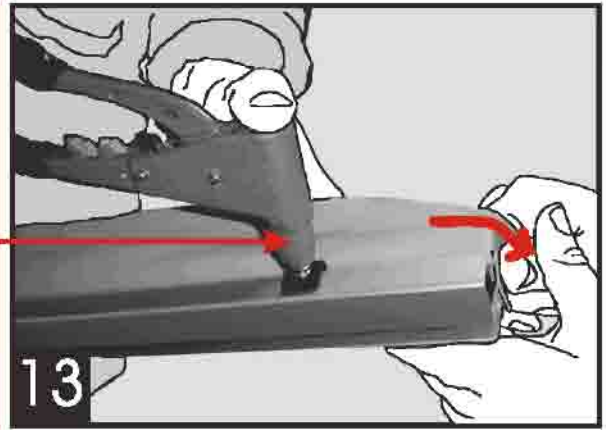
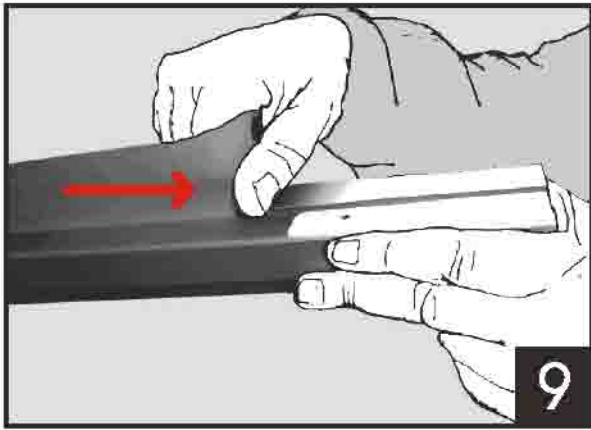
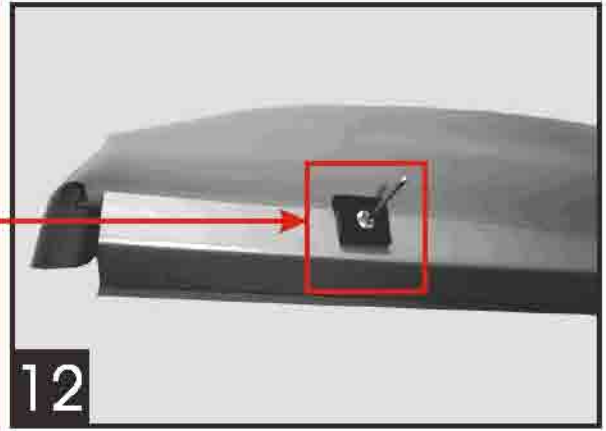
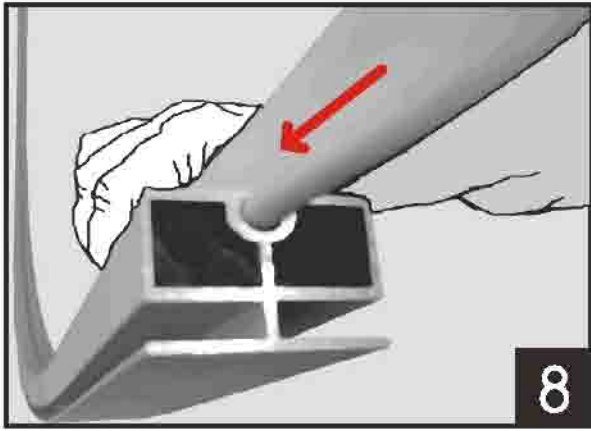
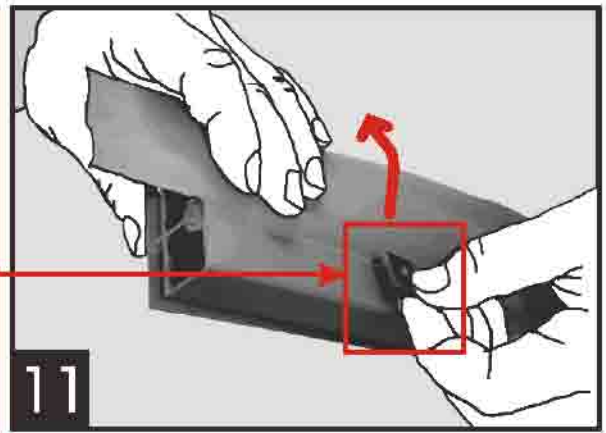
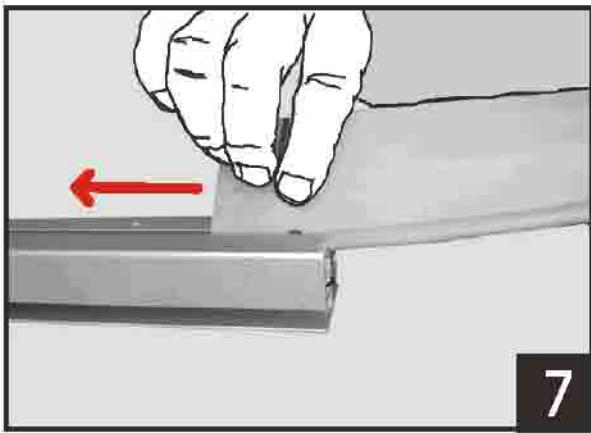
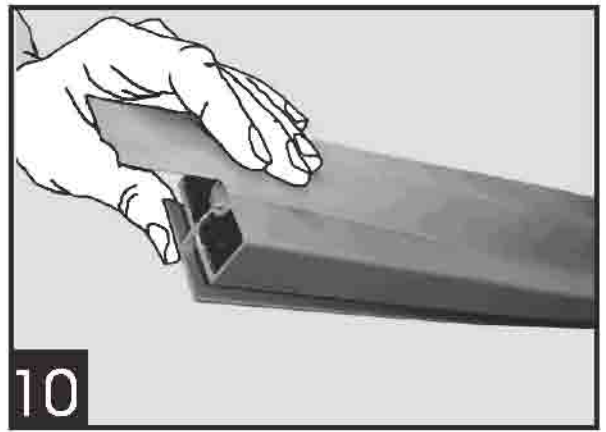
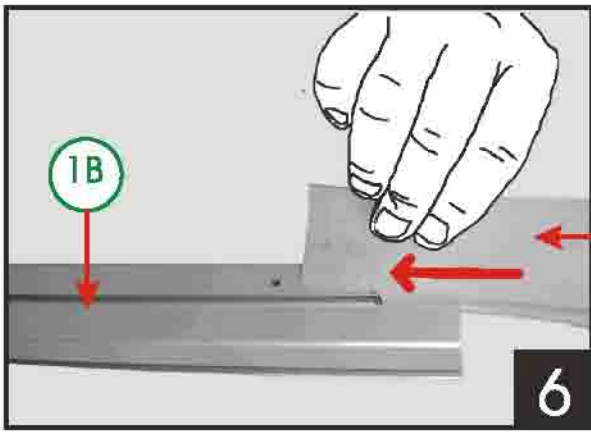

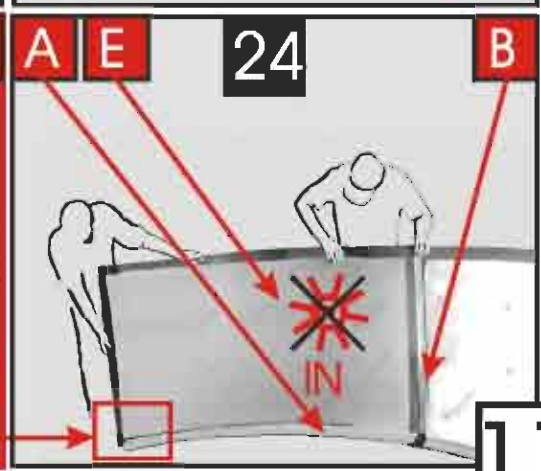
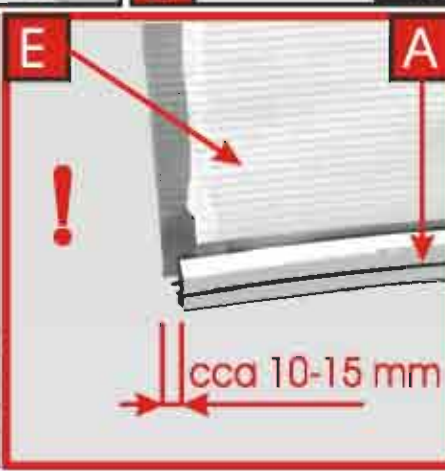
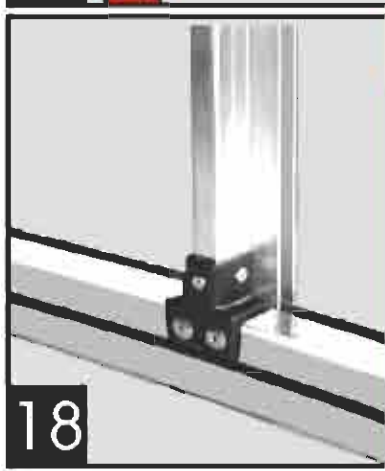
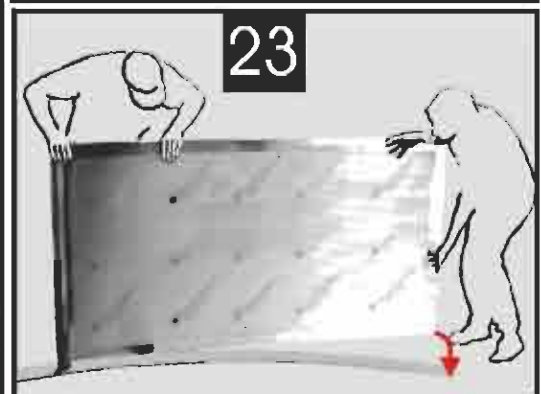
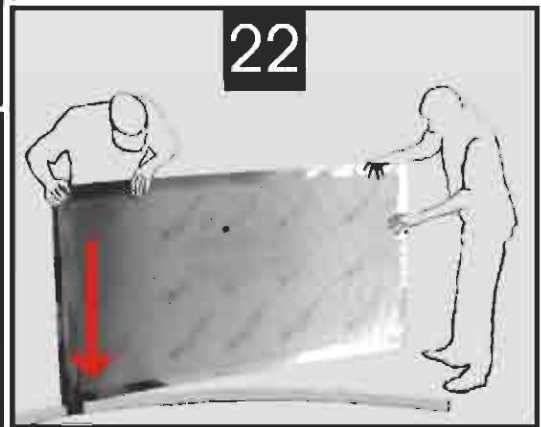
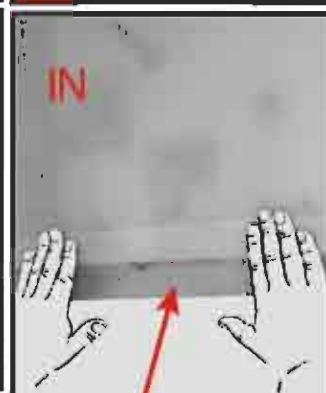
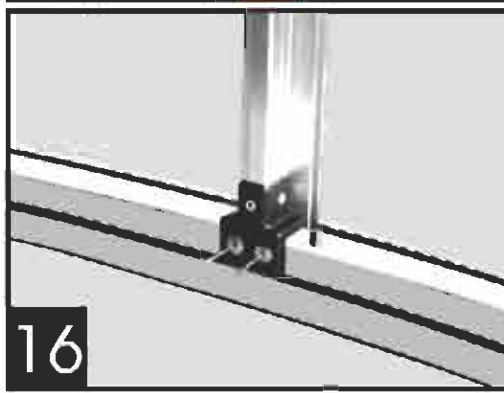
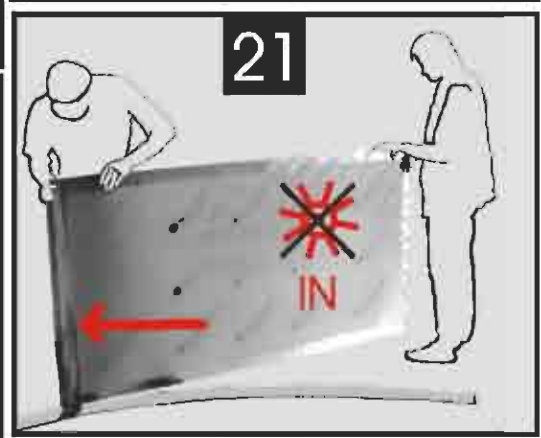
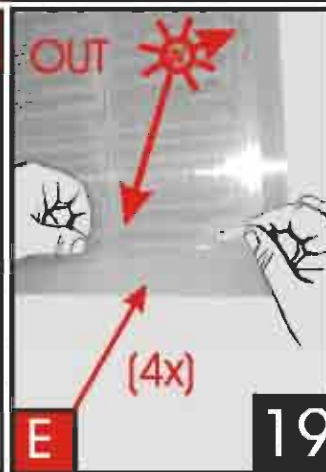
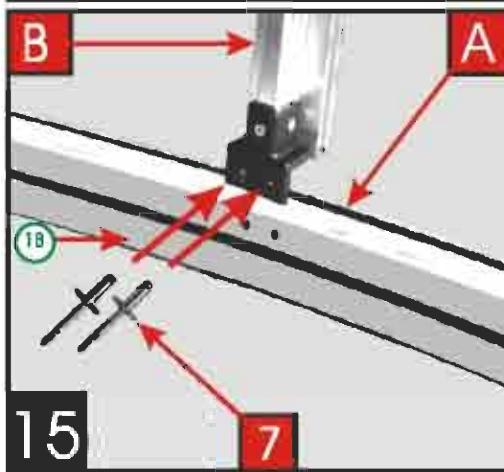
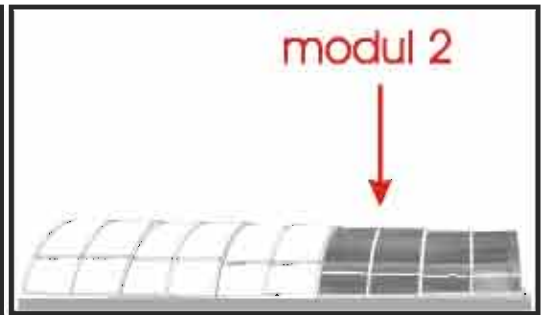
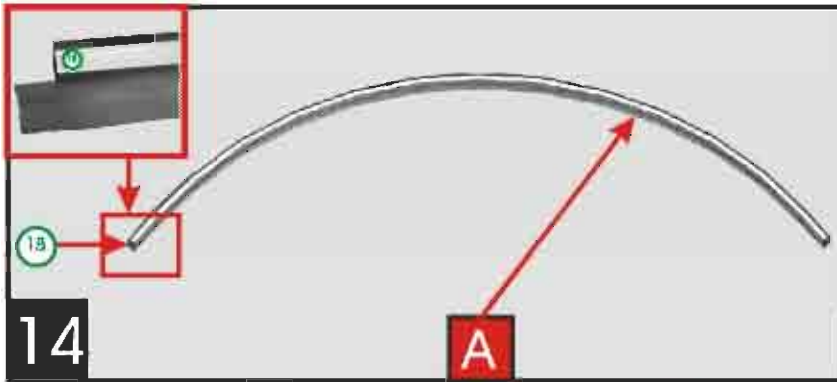

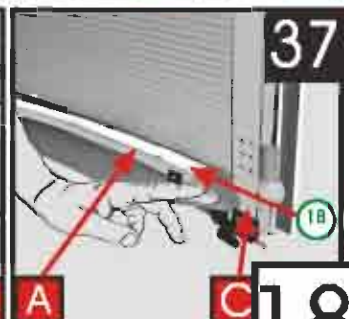
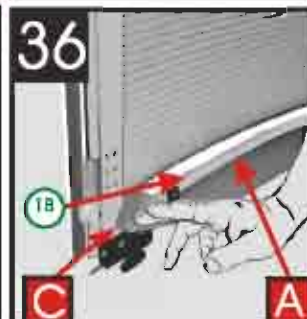
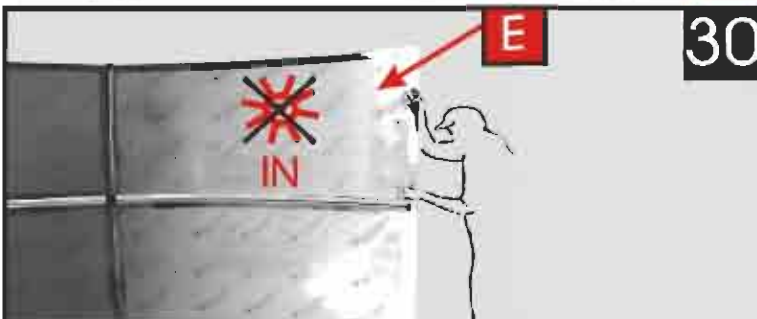
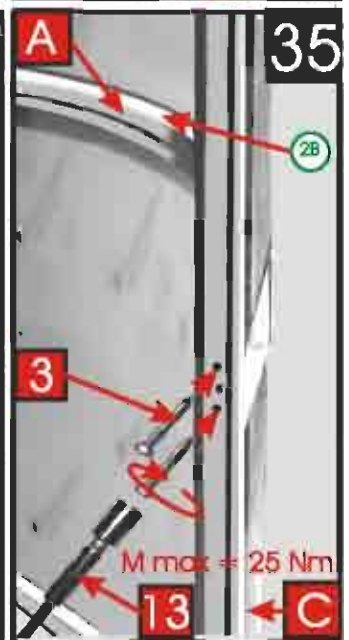
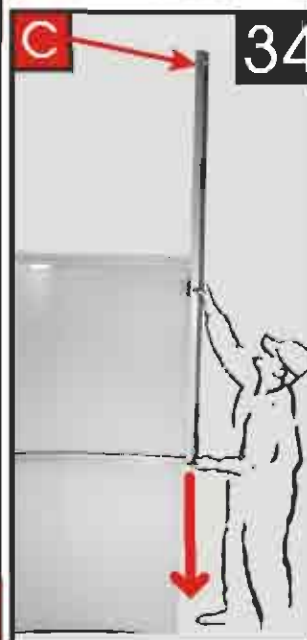
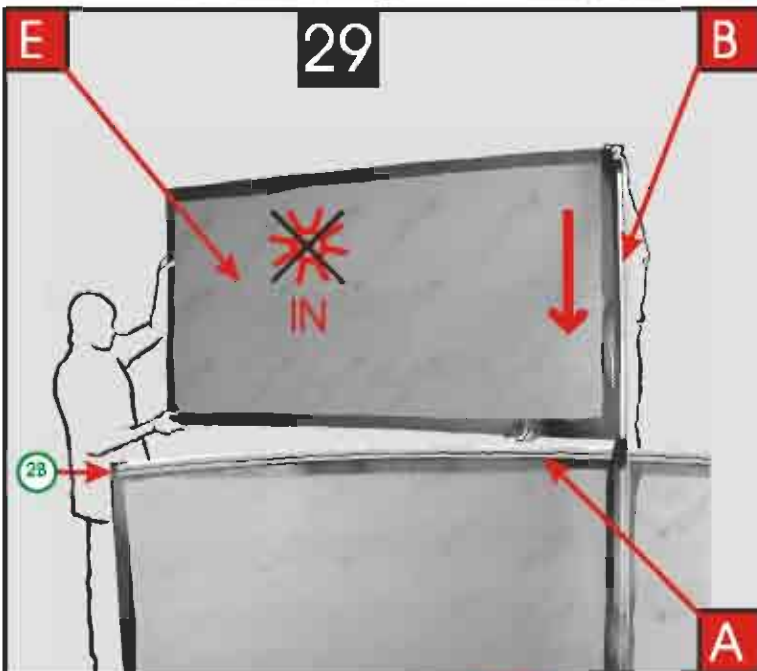
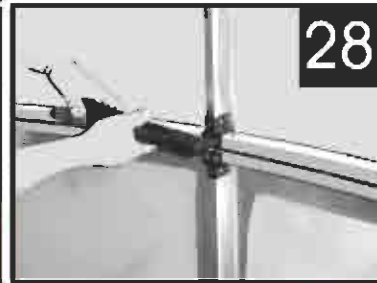
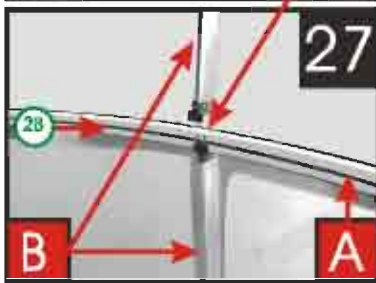
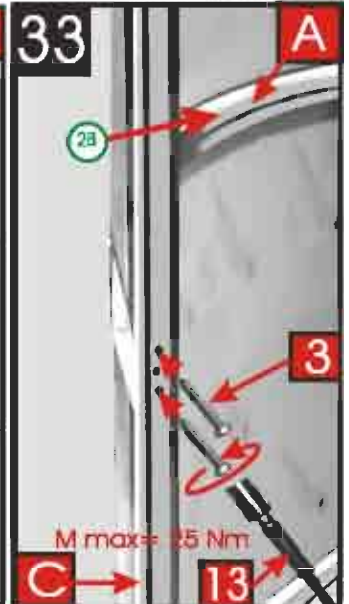
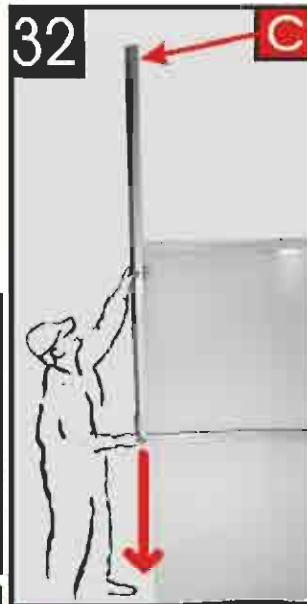
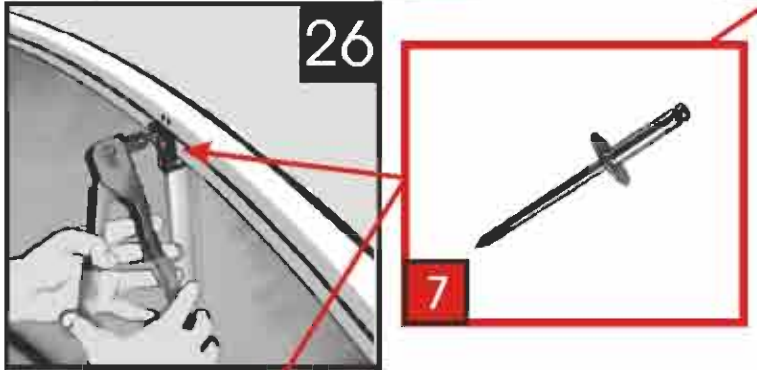
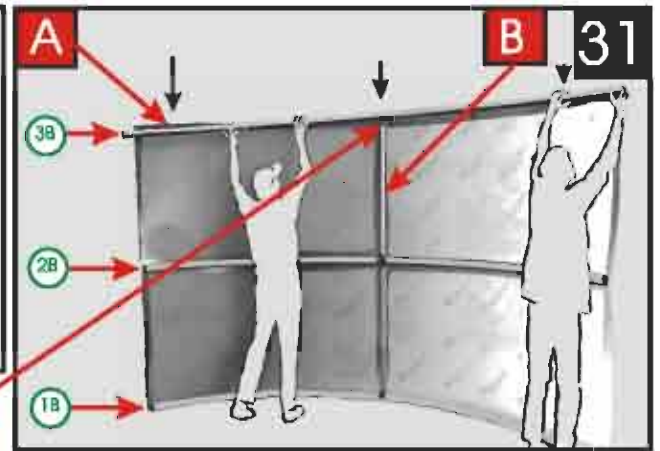
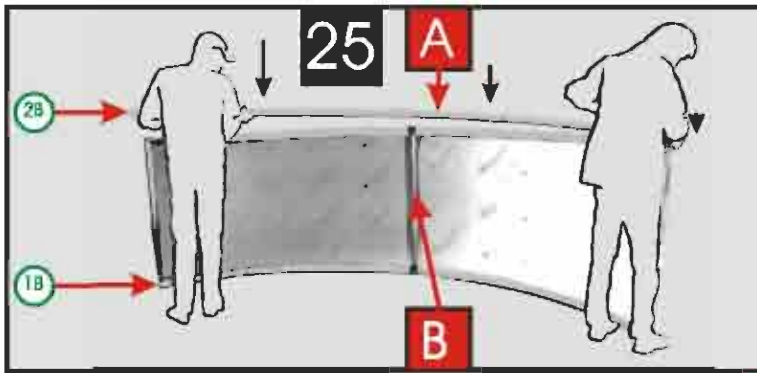

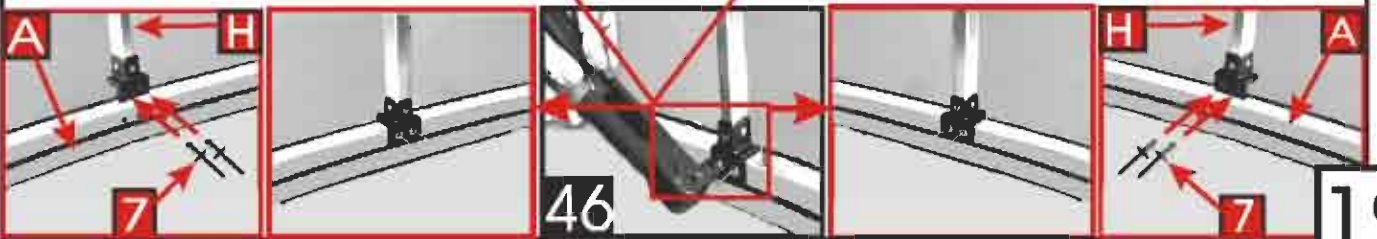
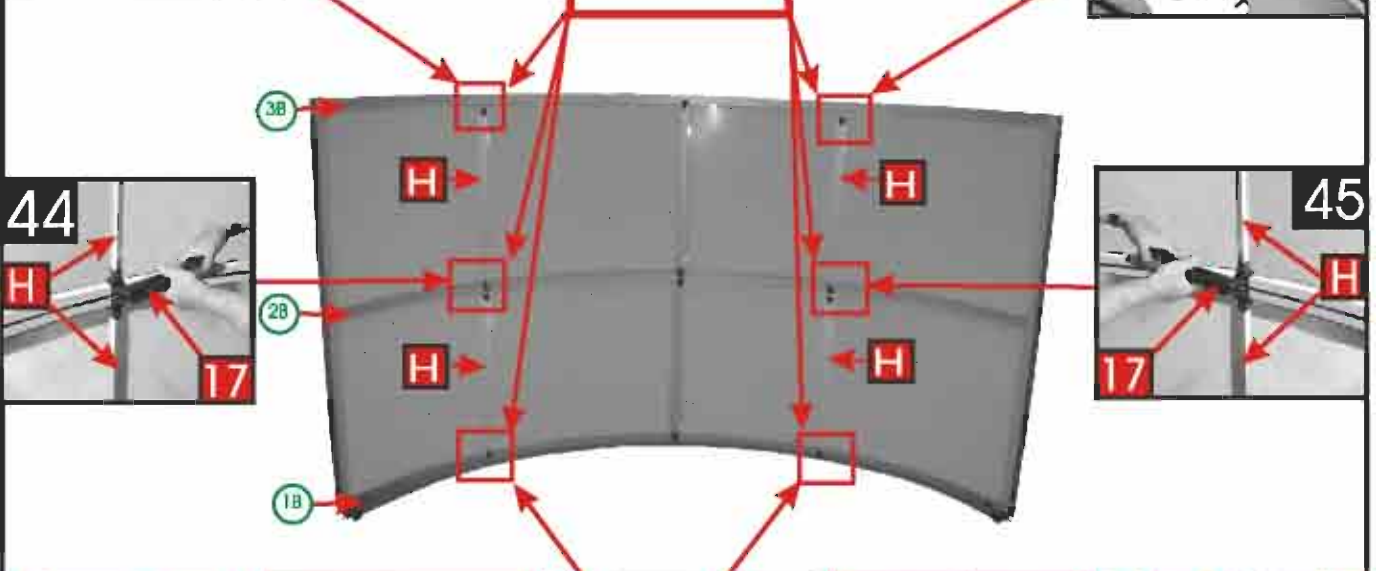
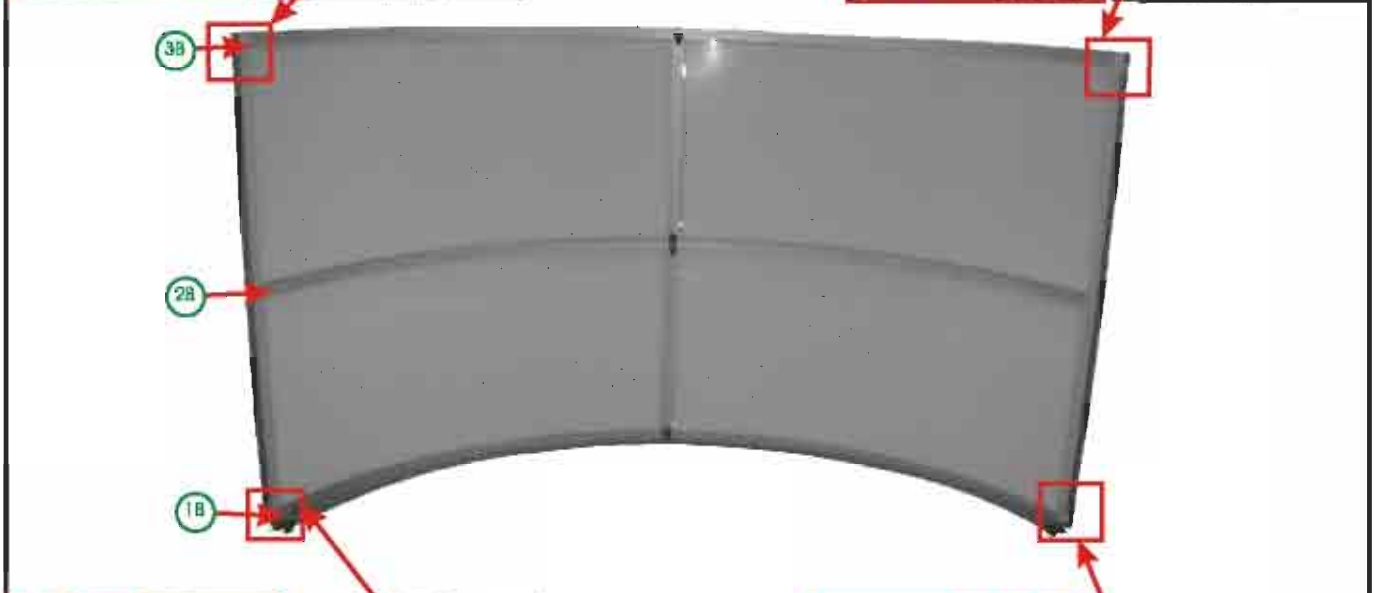

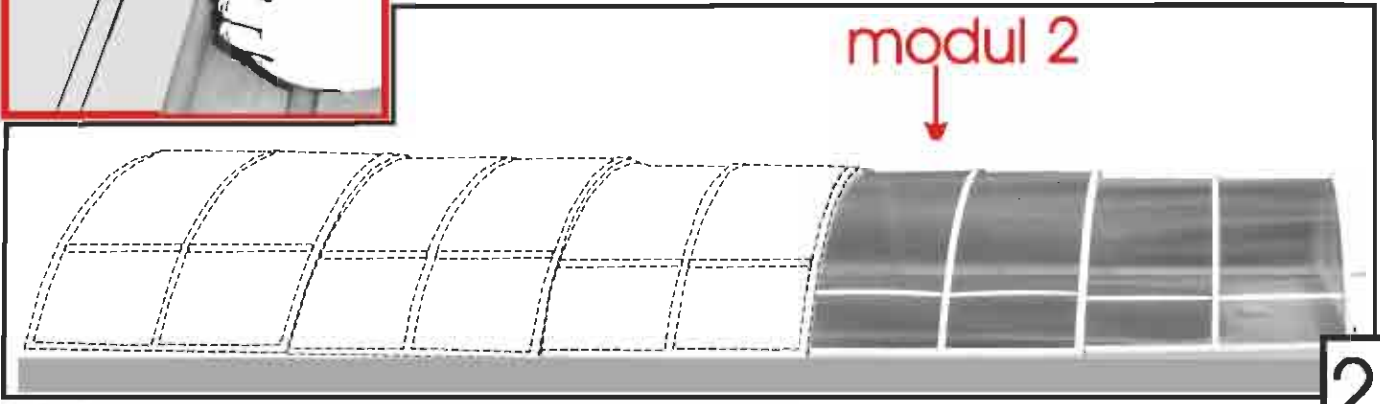
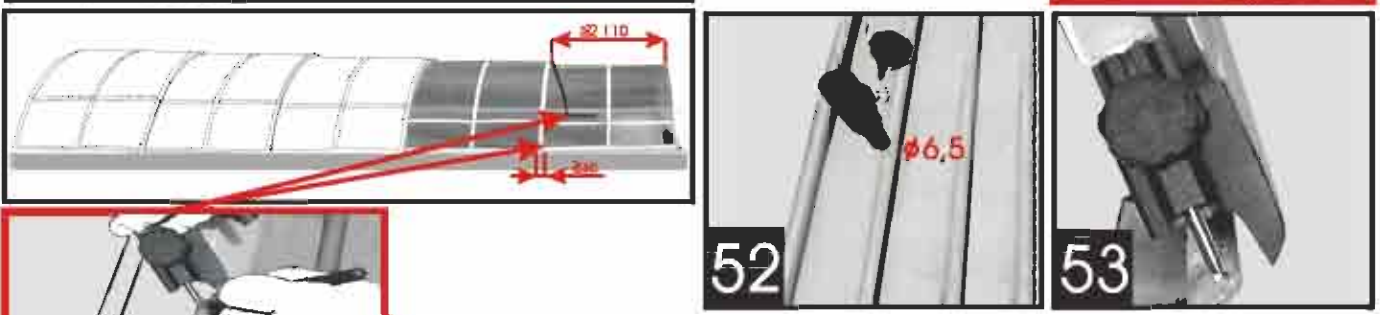
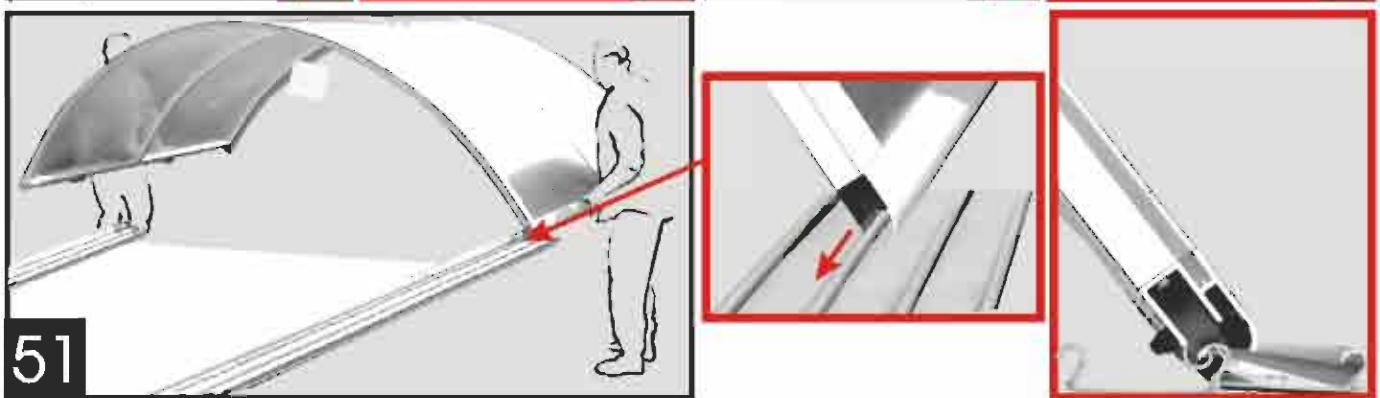
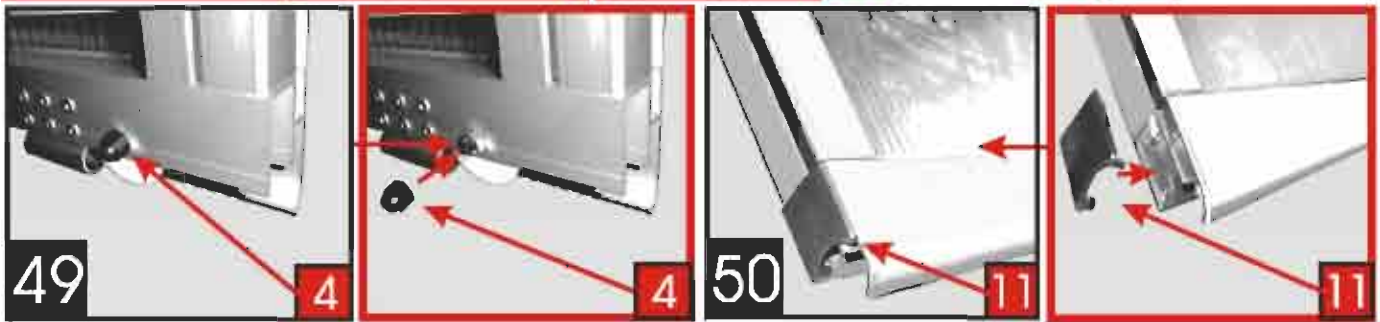
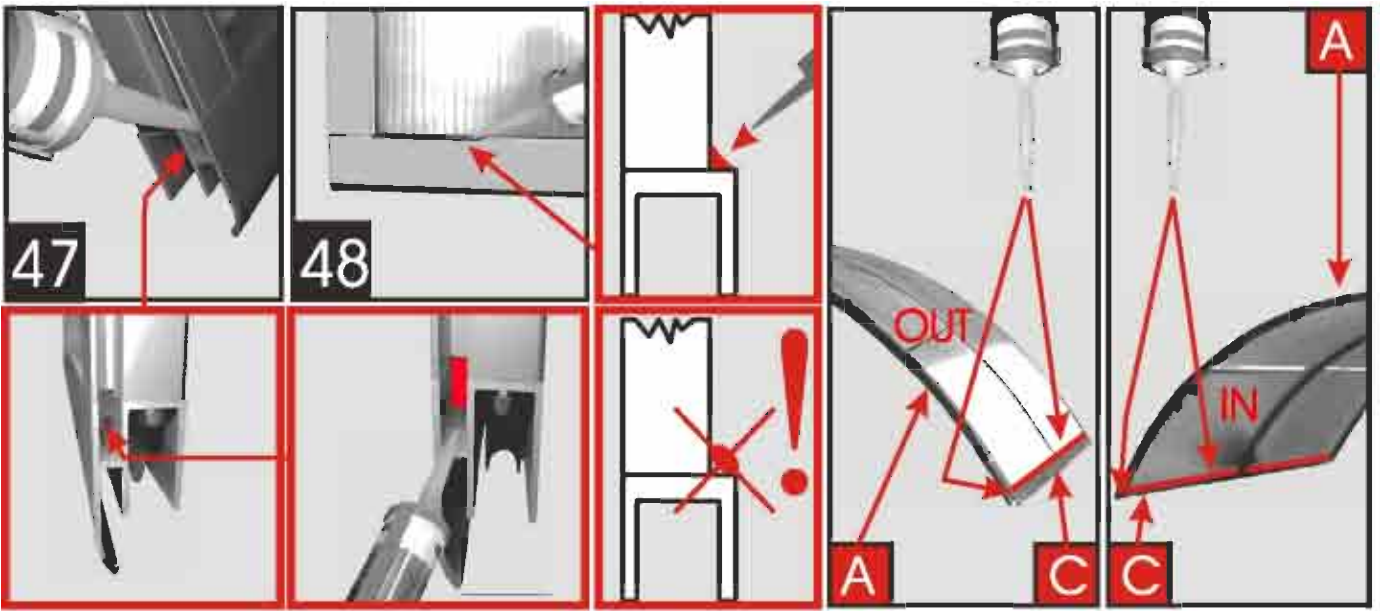

typ KLASIK C  
 modul 3

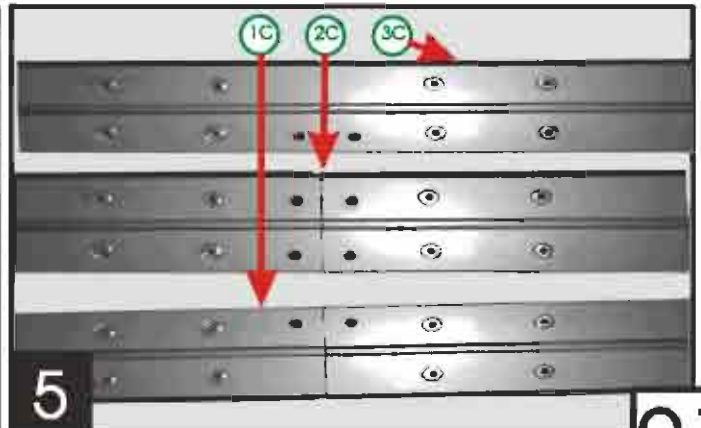
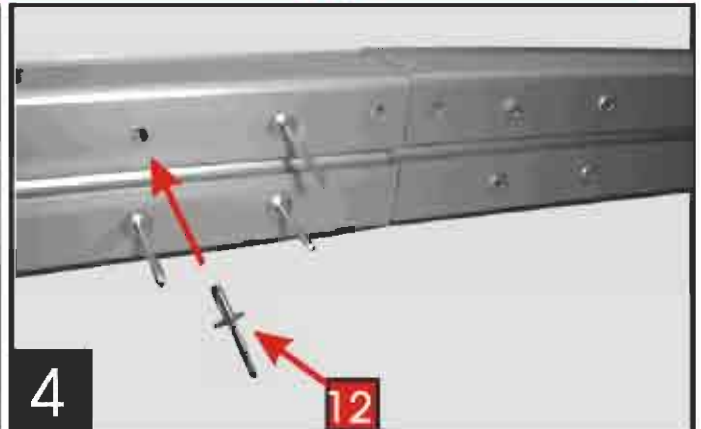
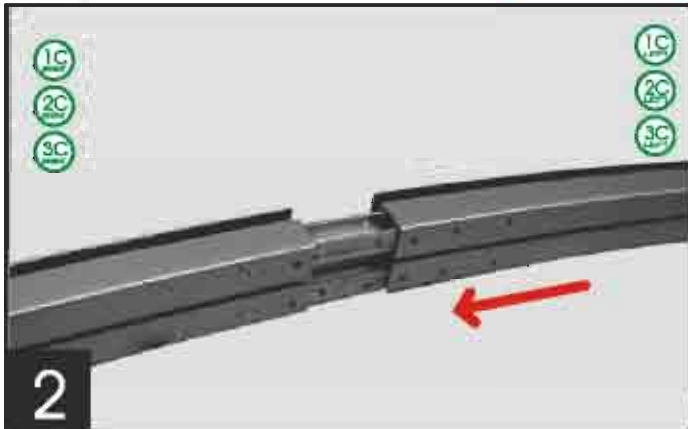
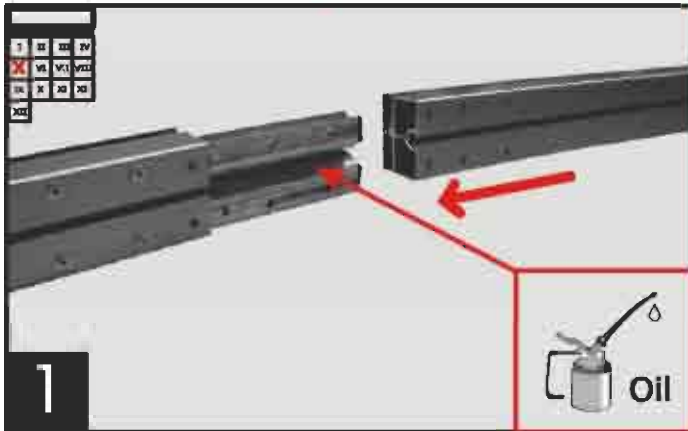
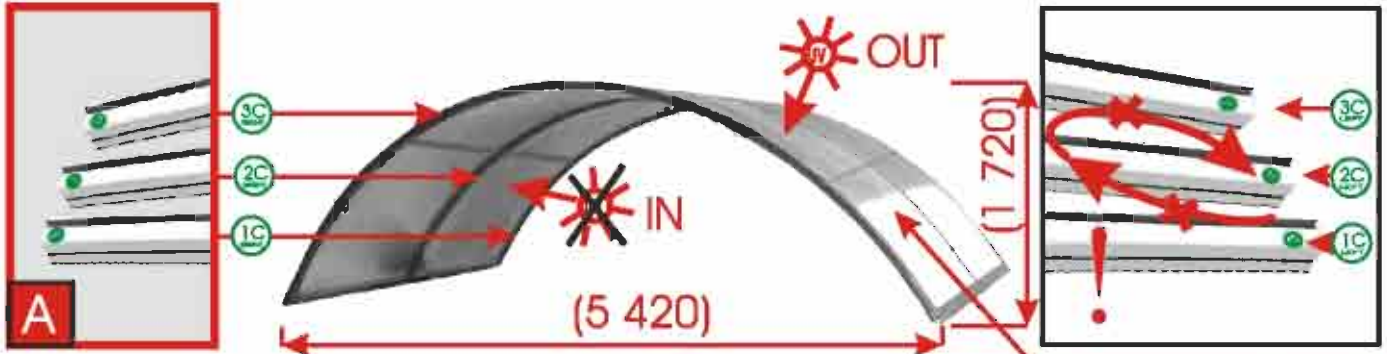
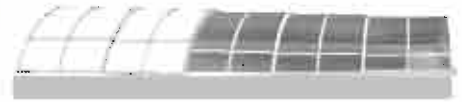

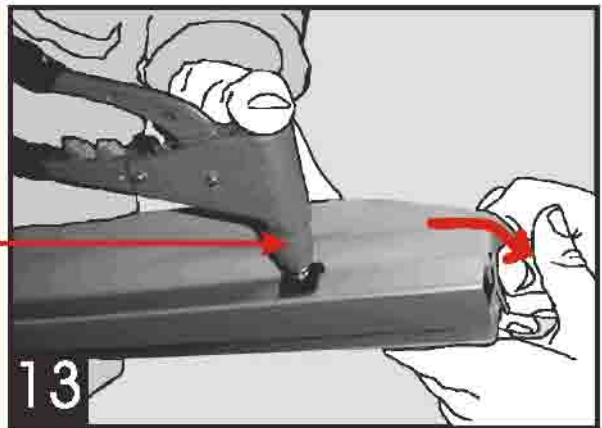
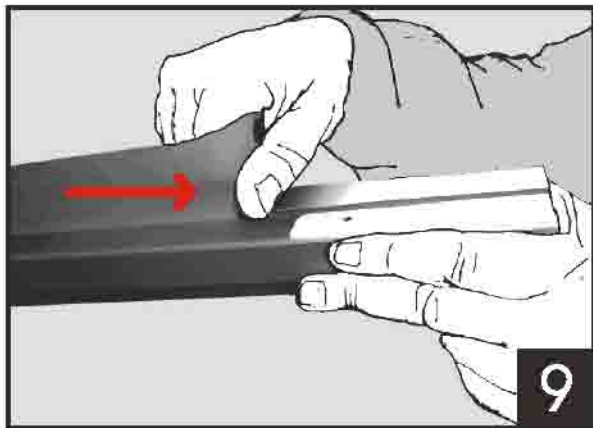
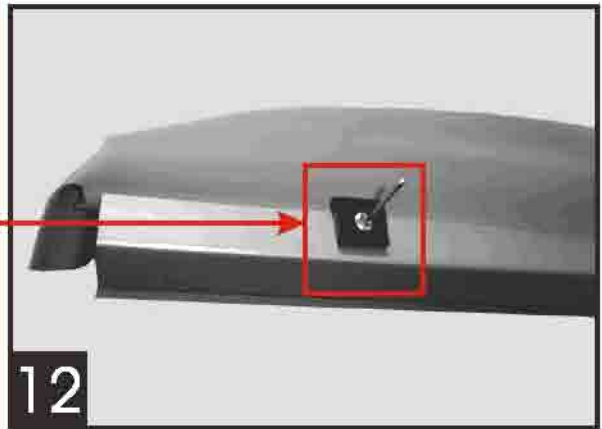
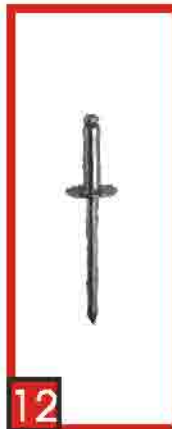
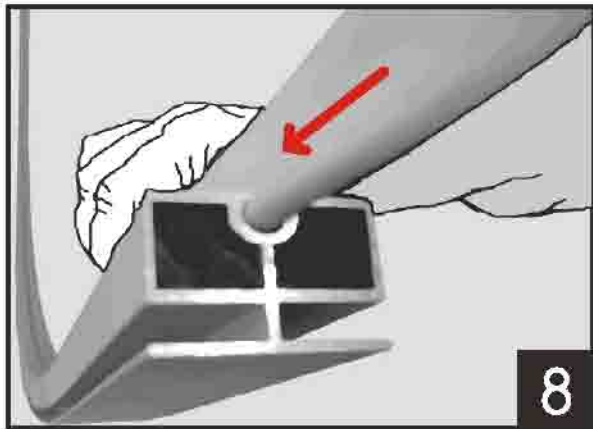
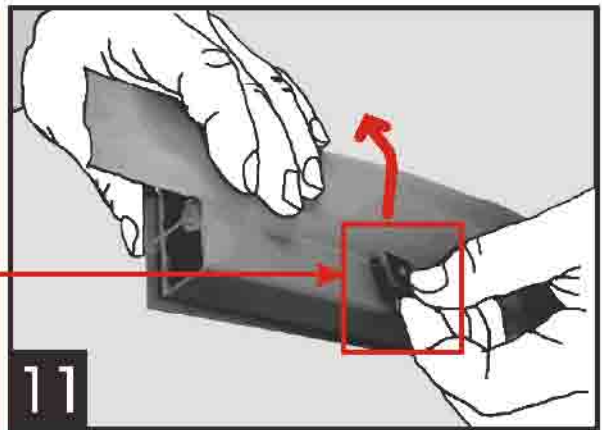
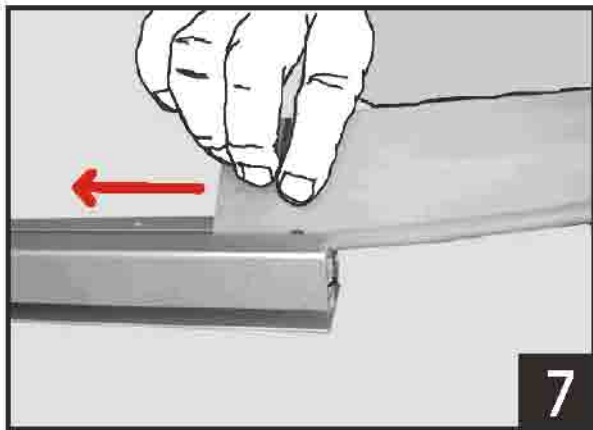
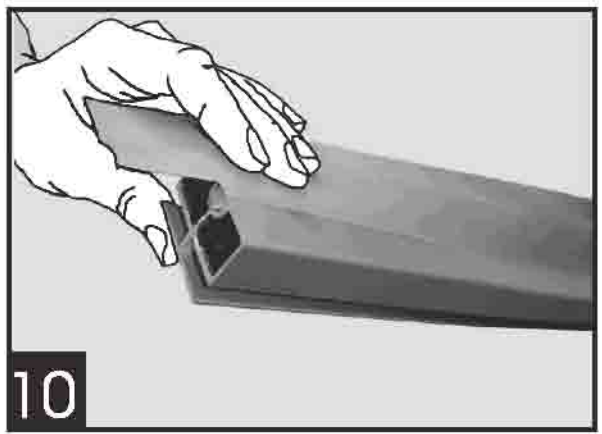
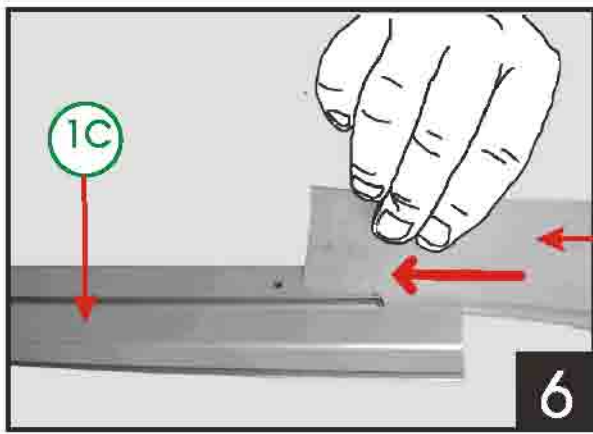

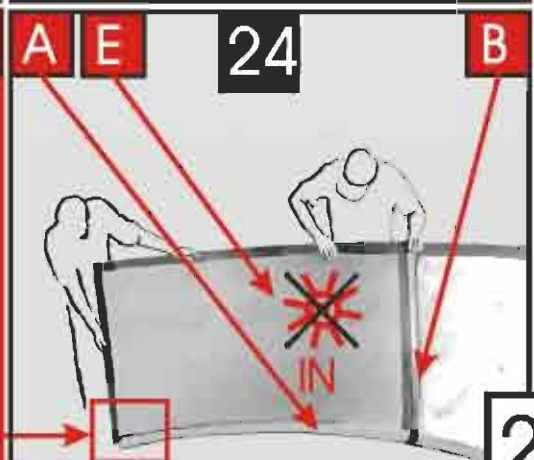
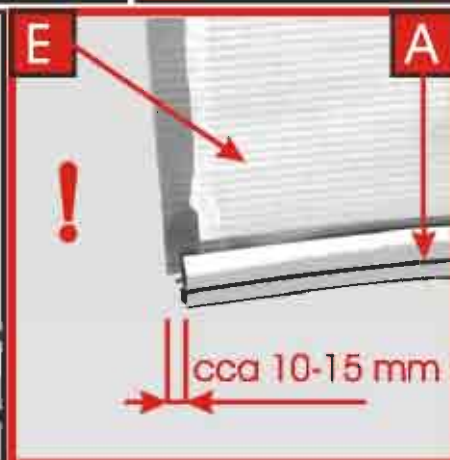
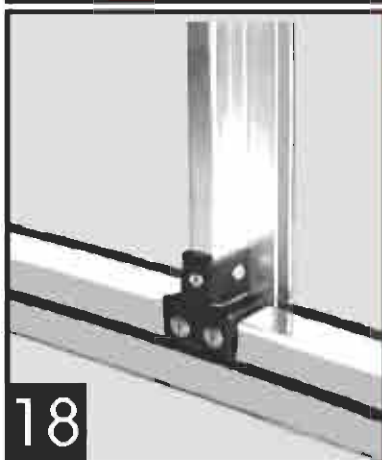
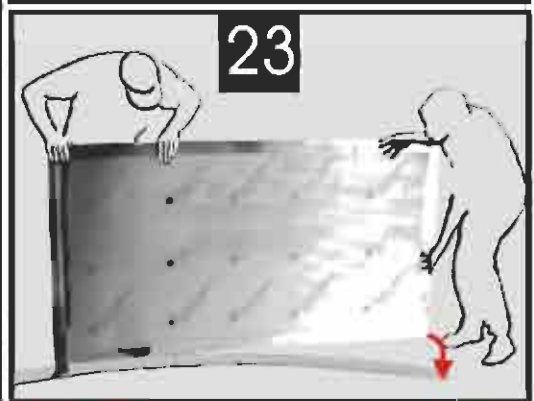
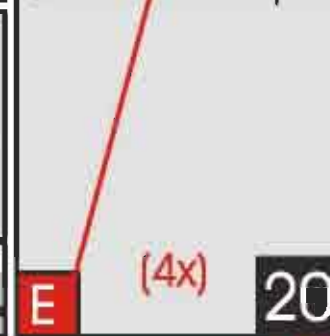
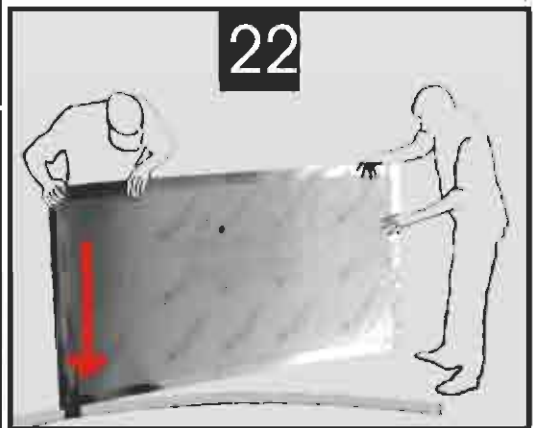
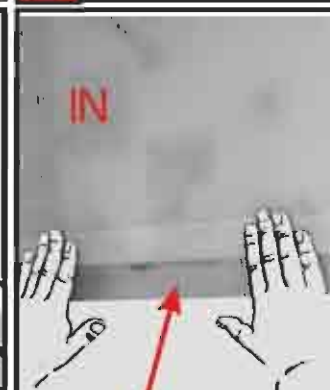
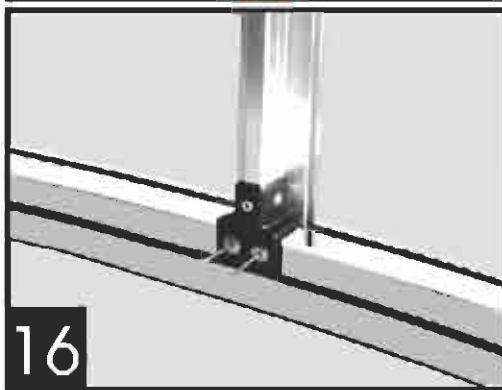
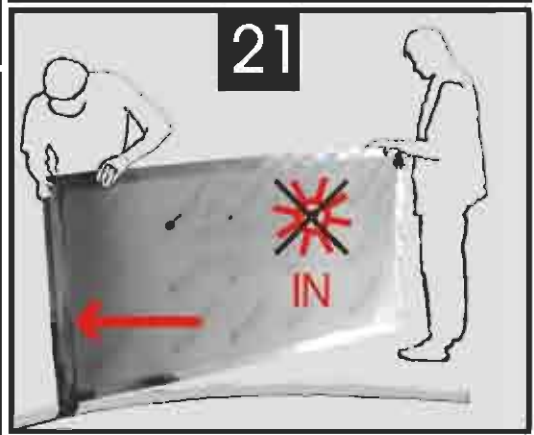
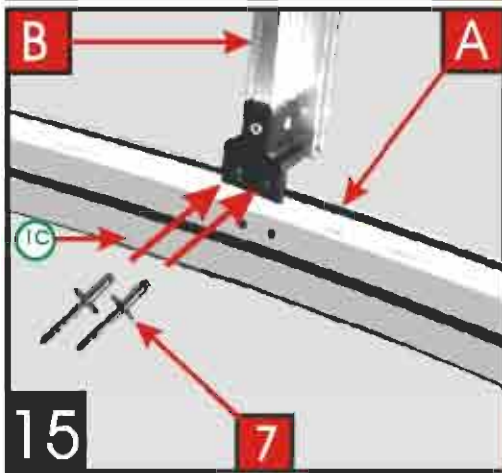
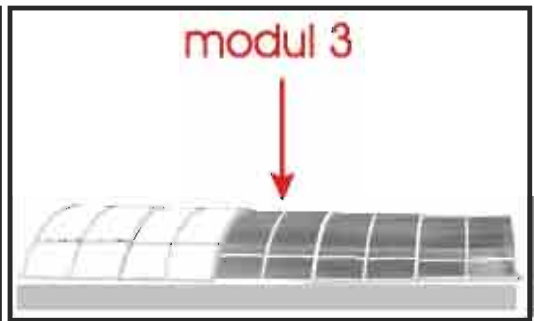
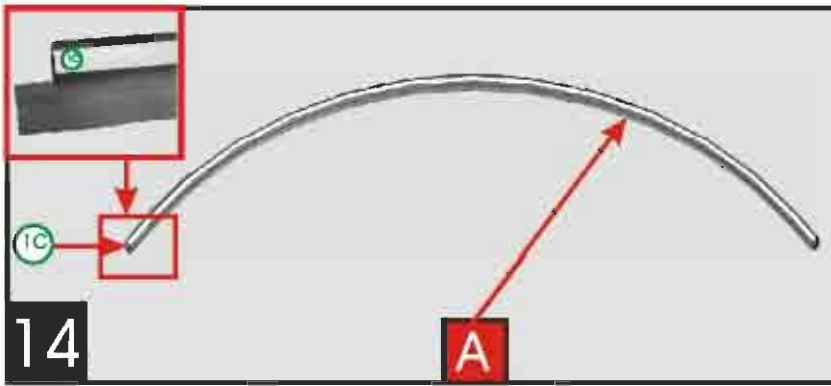



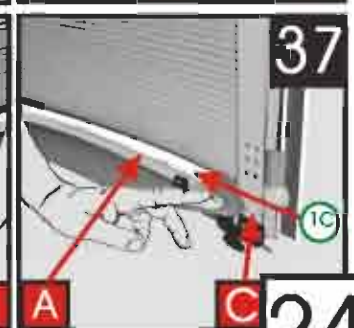
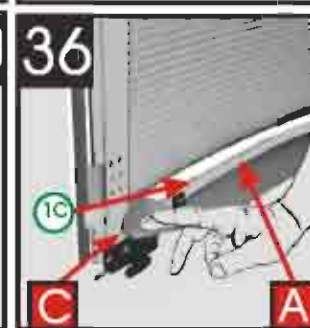
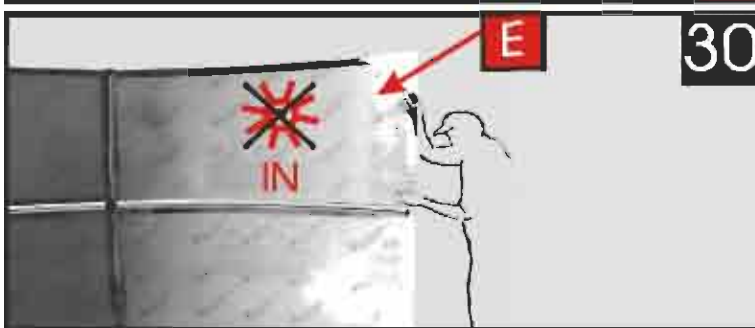
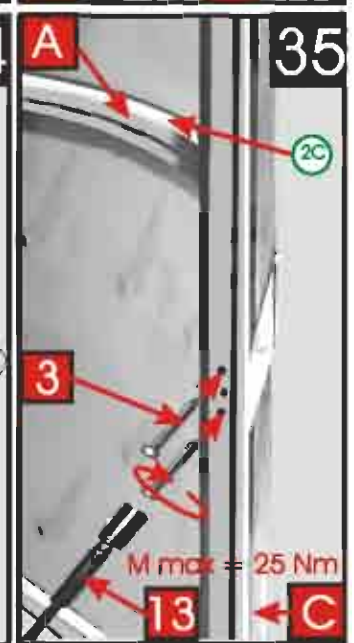
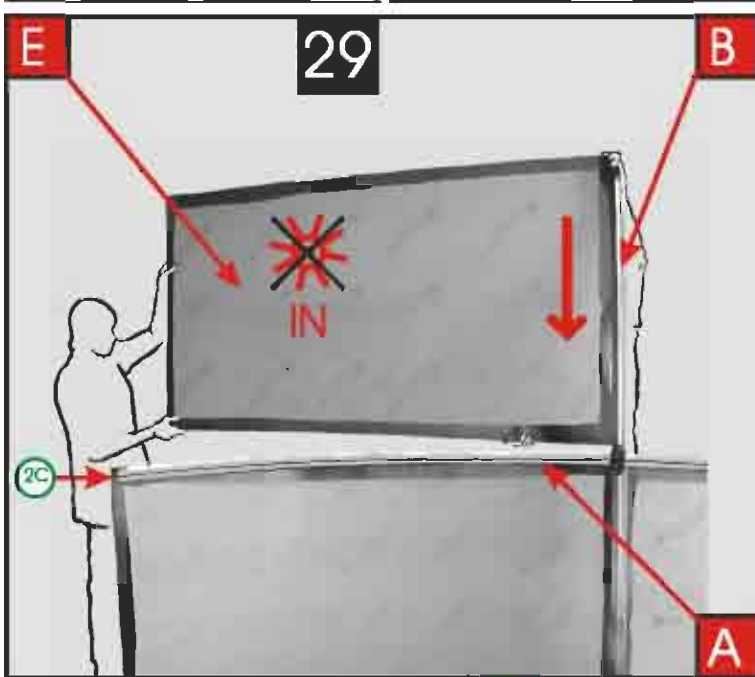
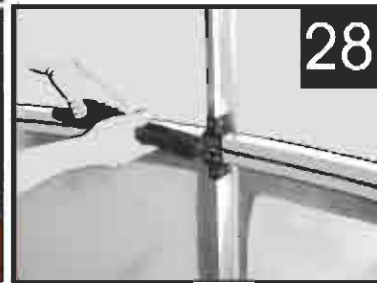
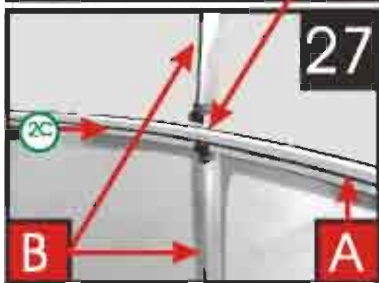
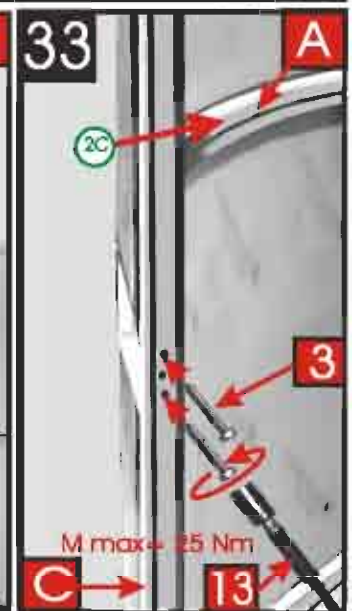
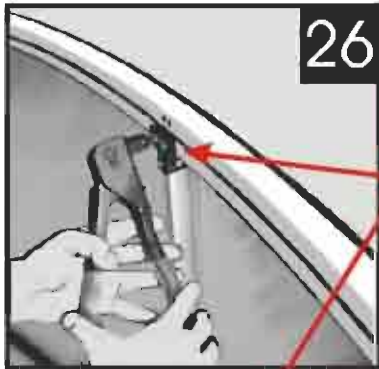
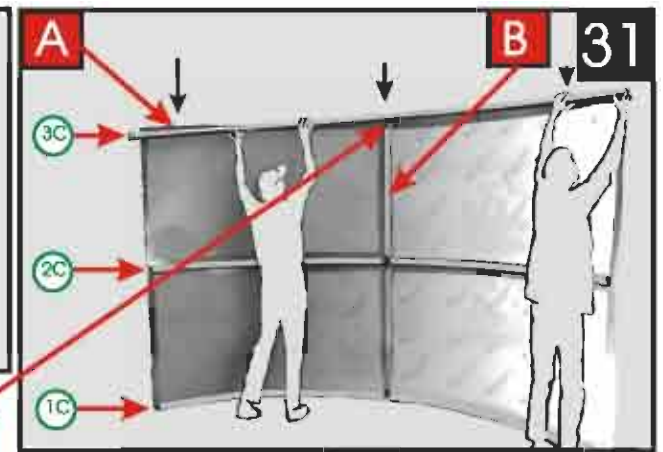
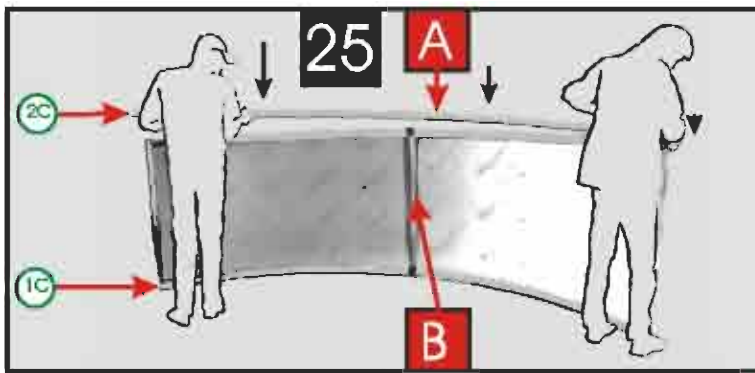

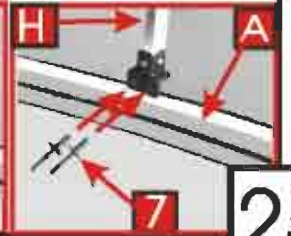
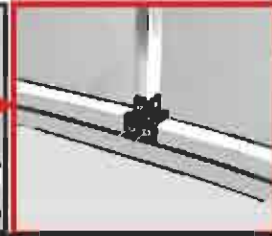
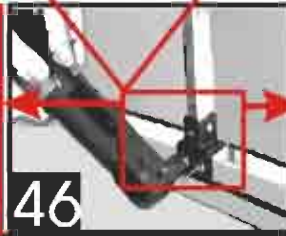
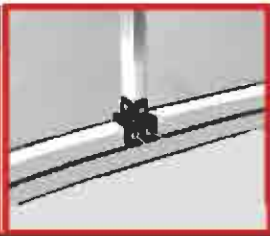
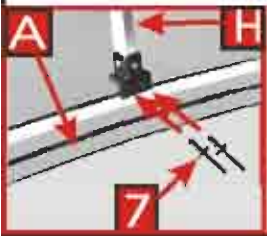
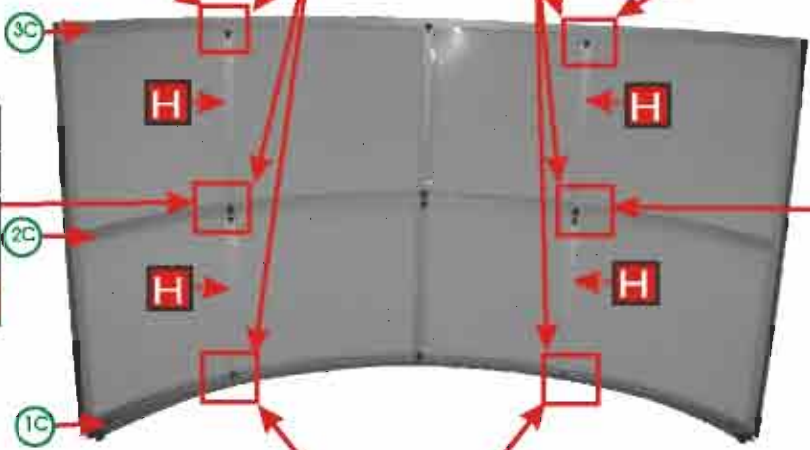
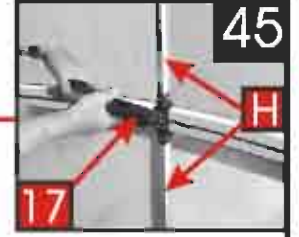
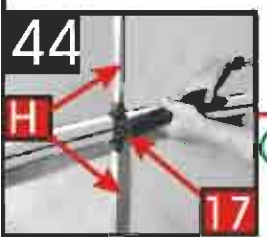
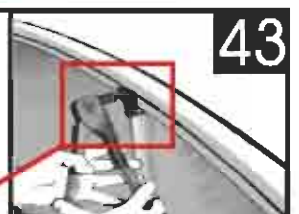
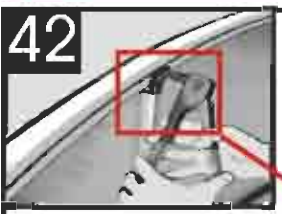
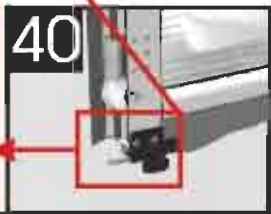
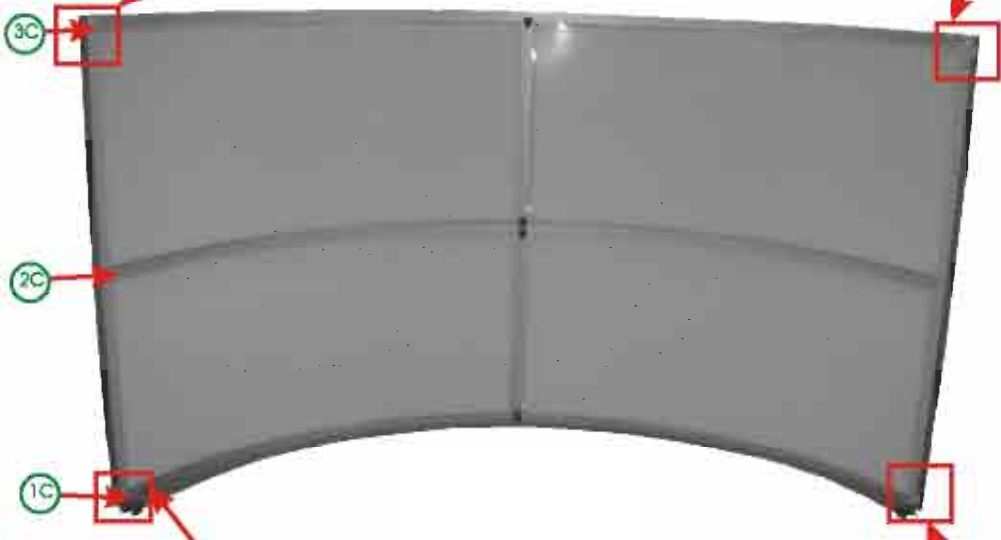

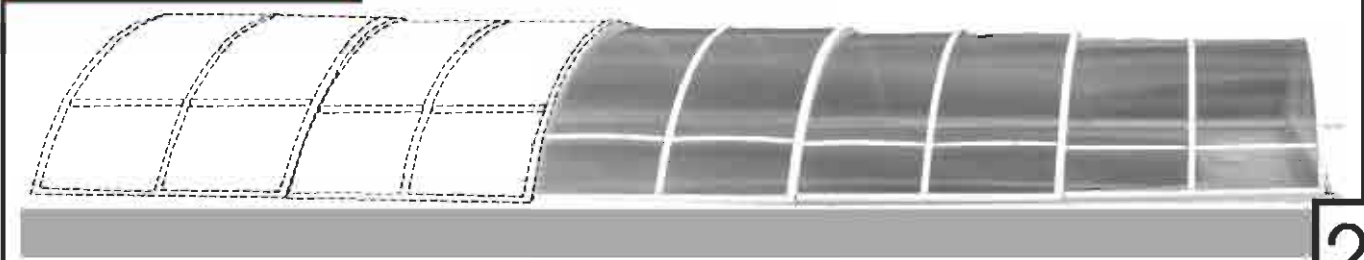
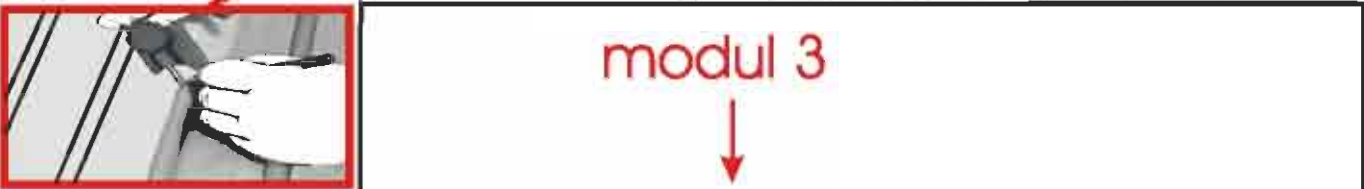
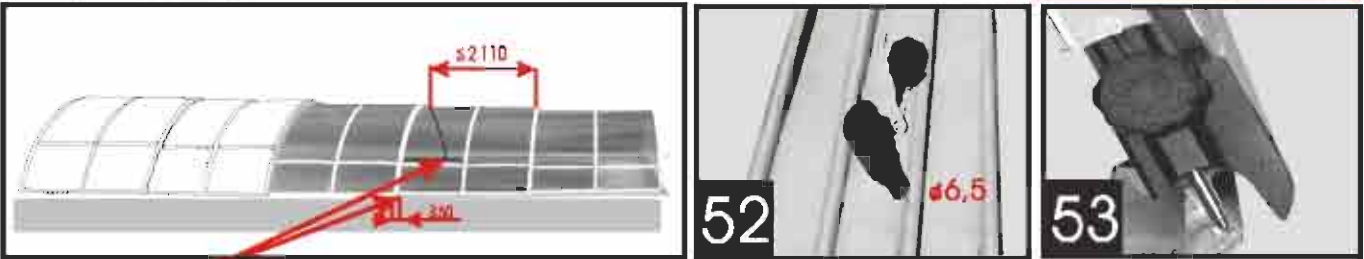
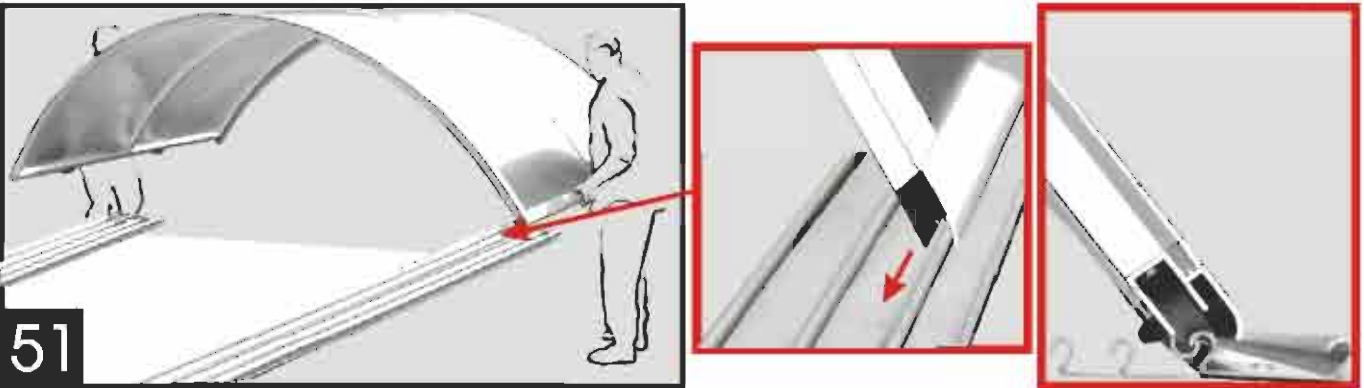
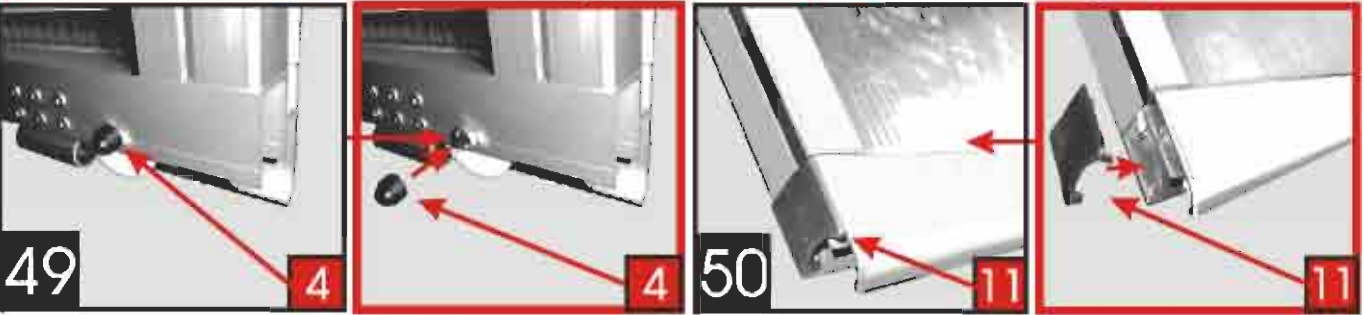
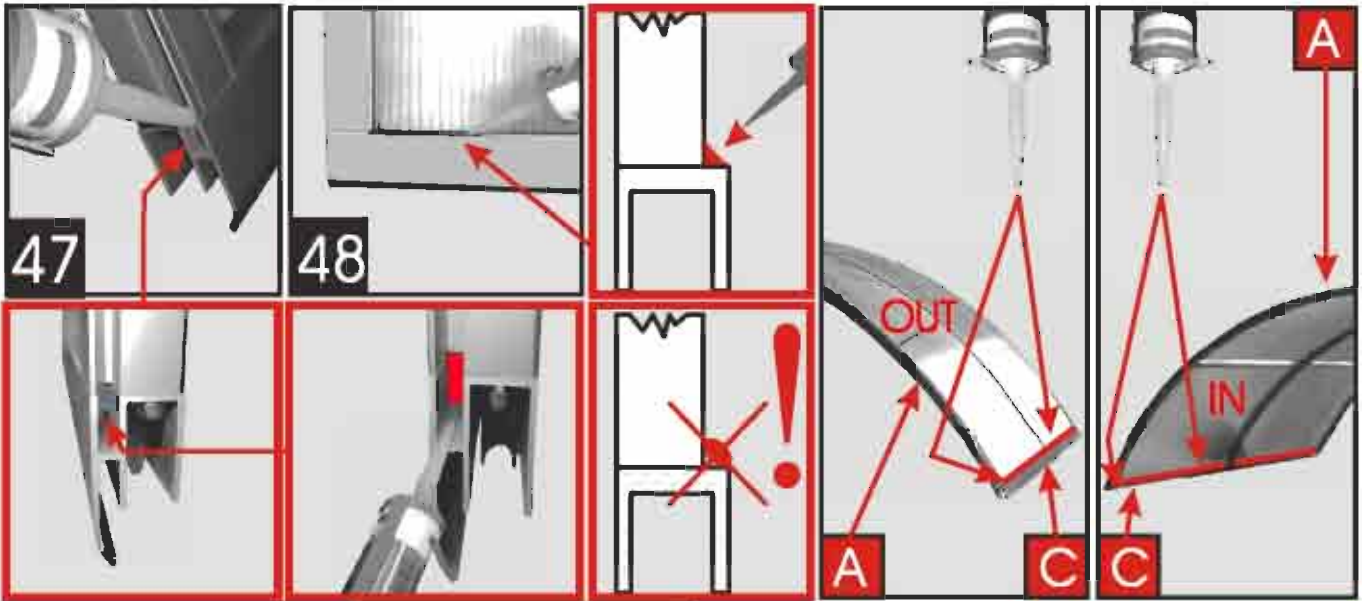

typ KLASIK C  
modul 4

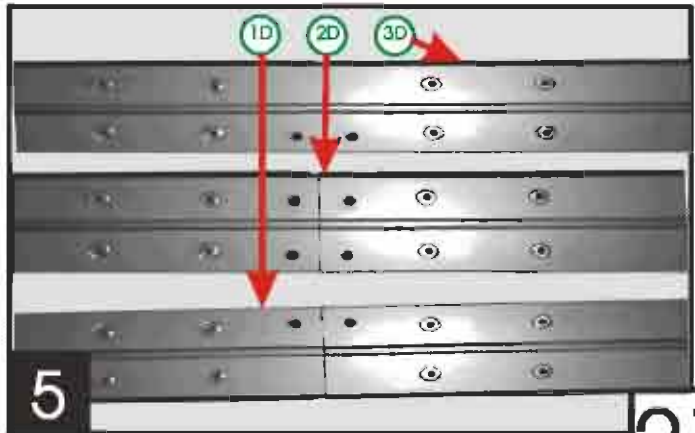
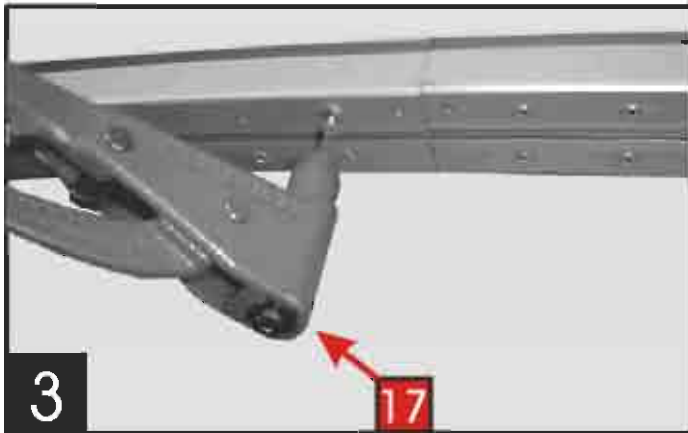
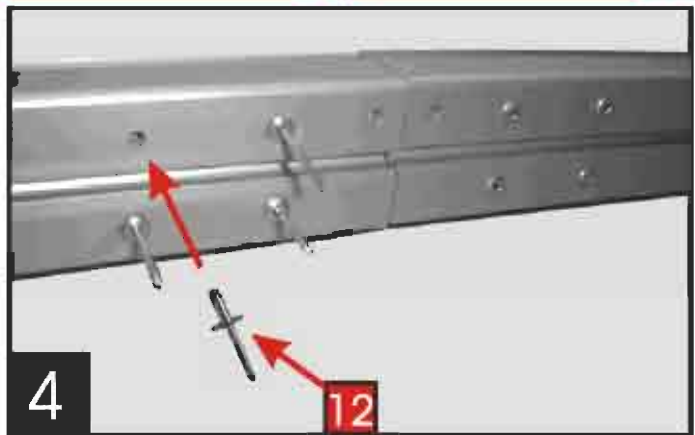
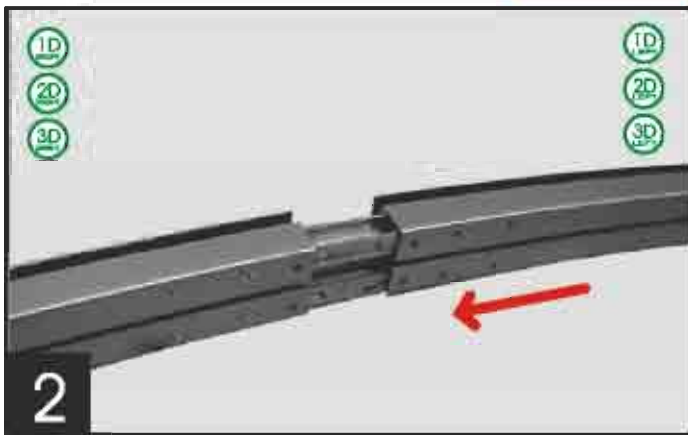
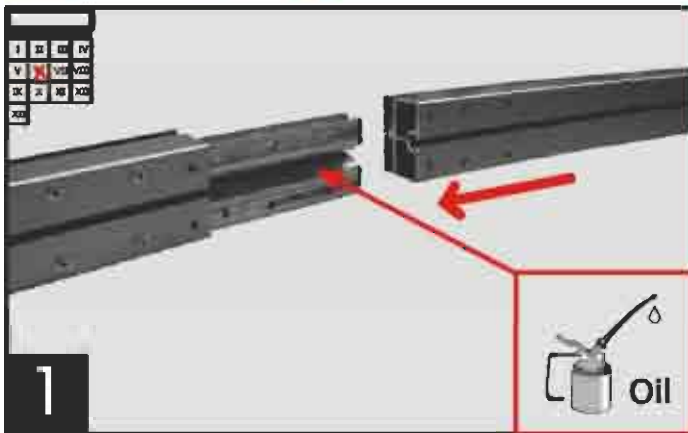
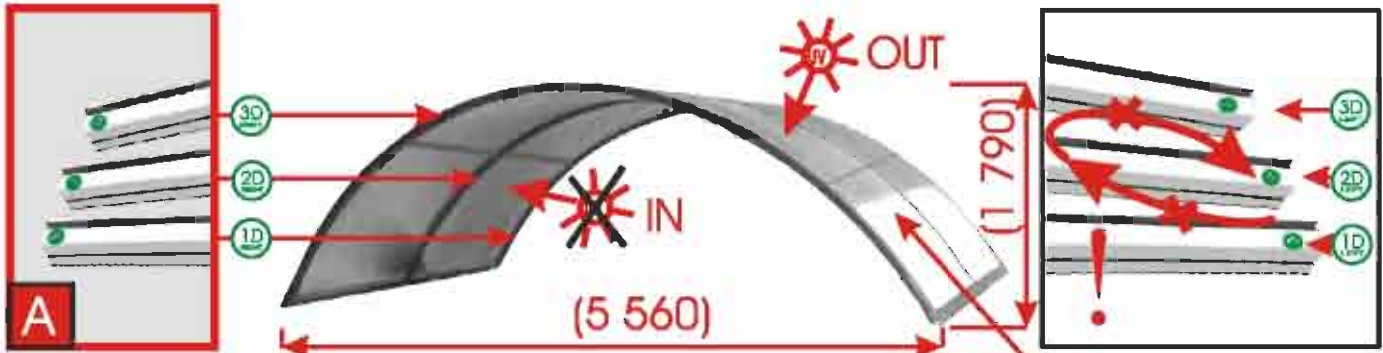

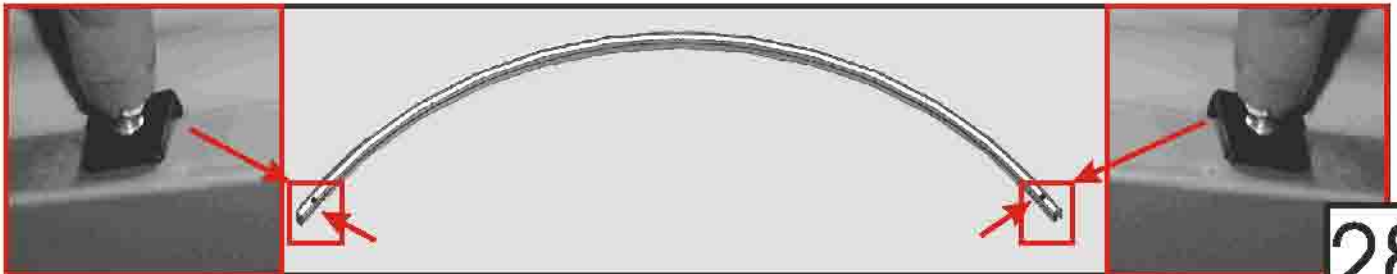
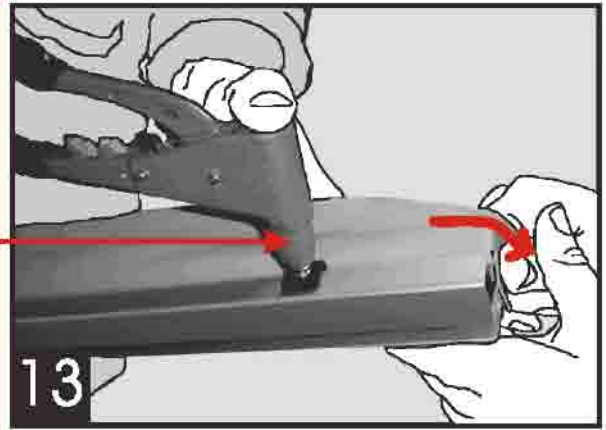
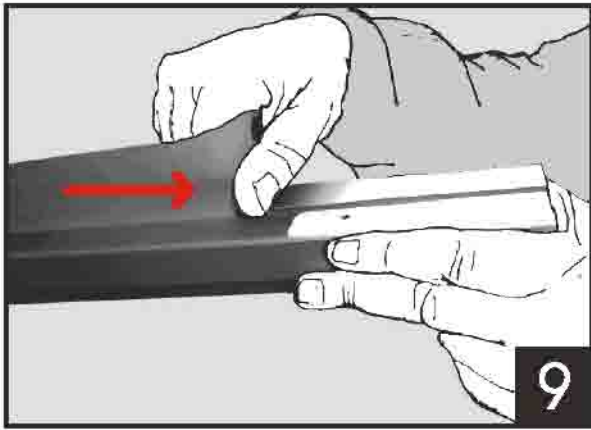
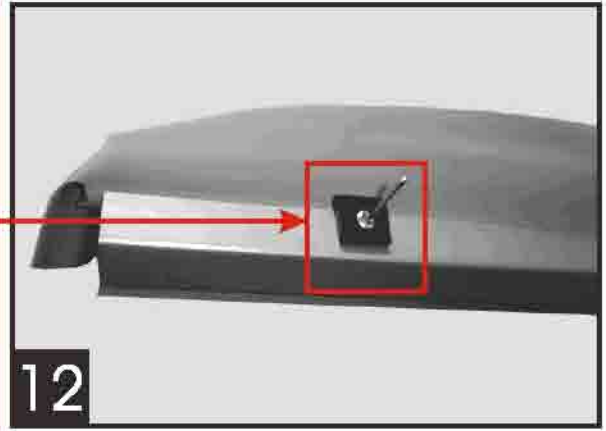
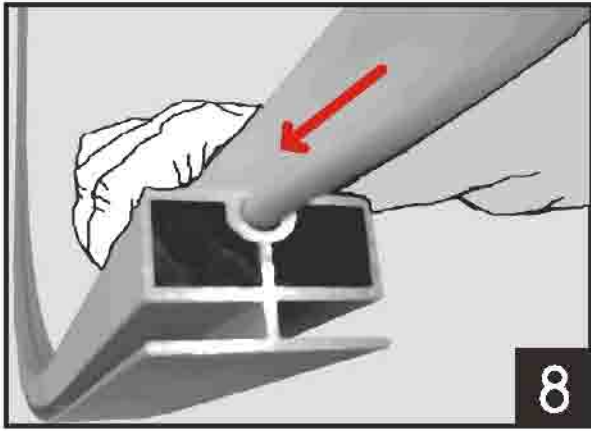
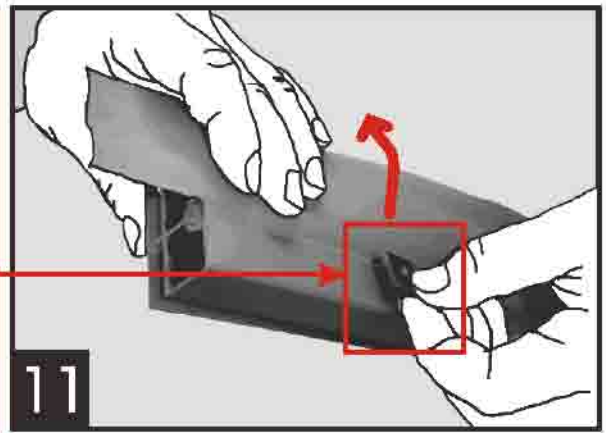
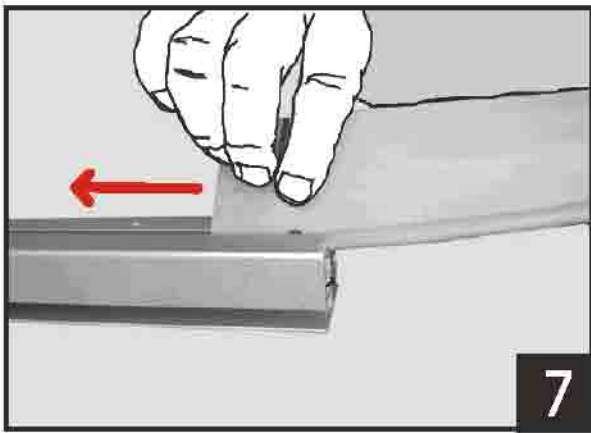
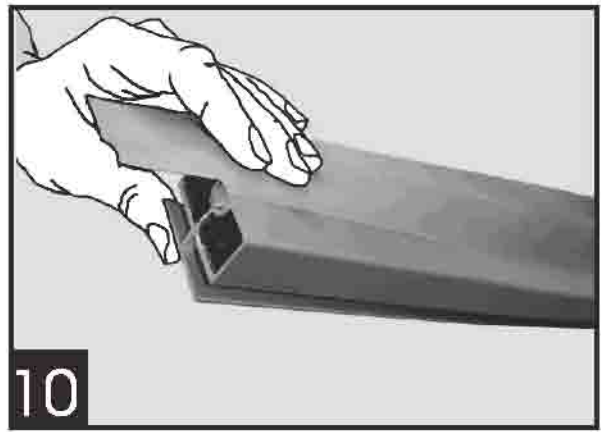
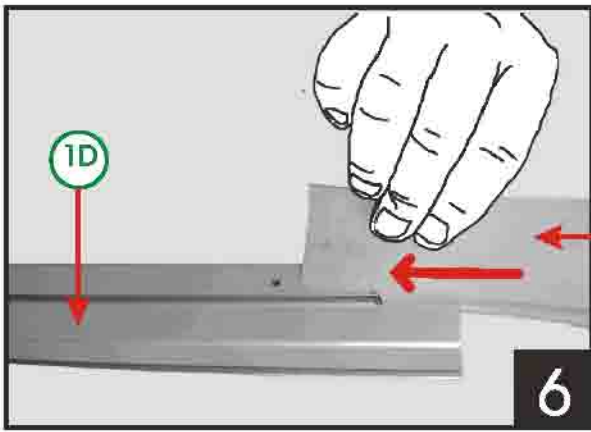

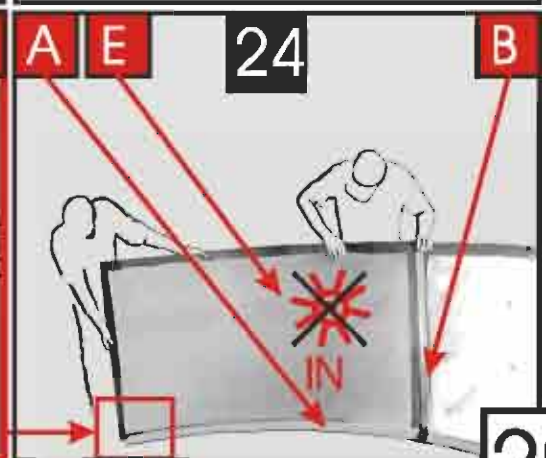
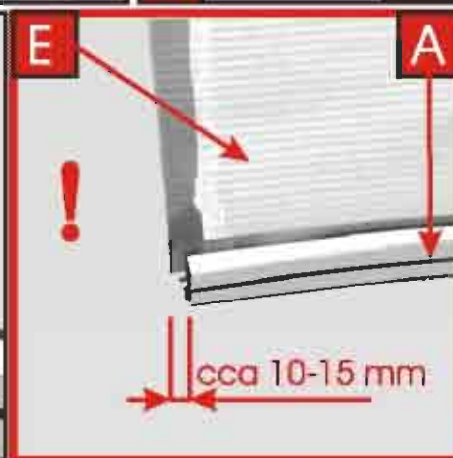
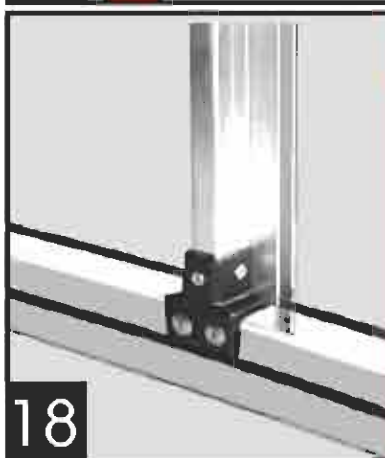
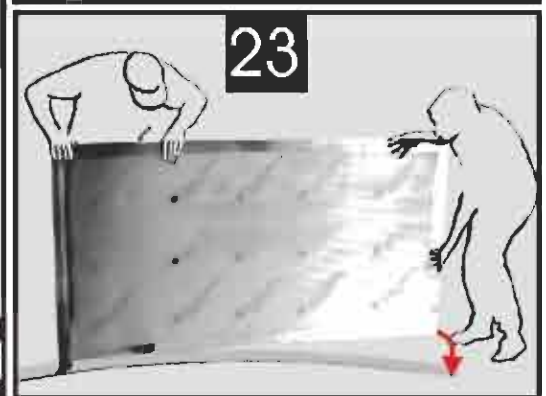
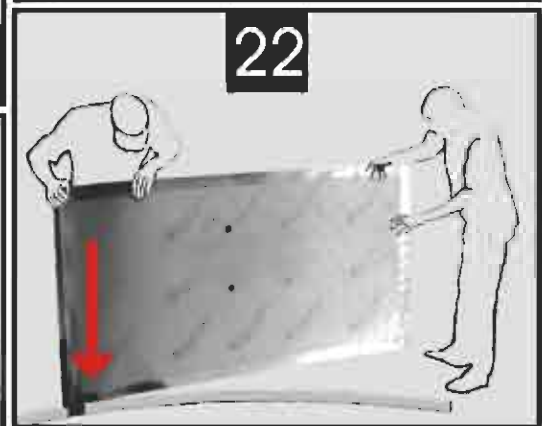
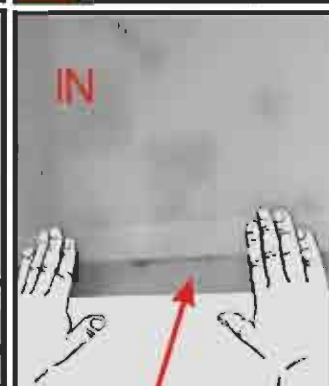
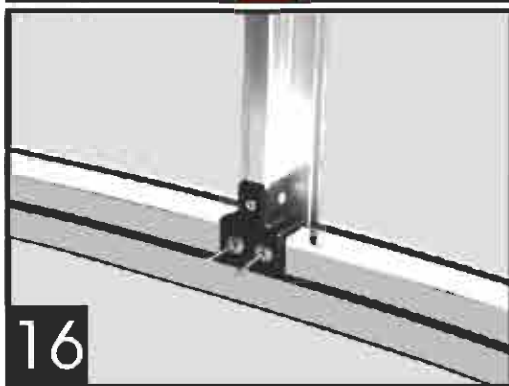
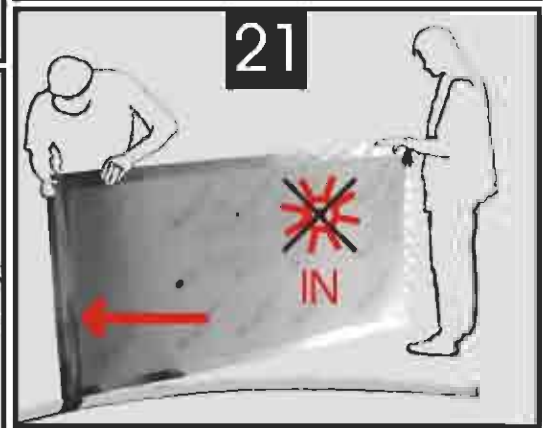
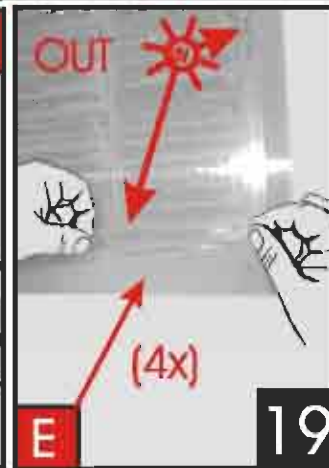
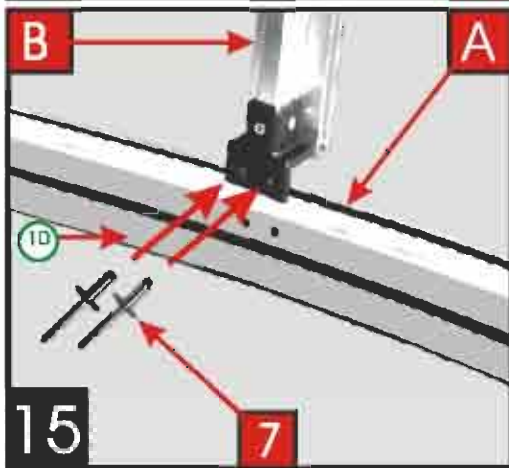
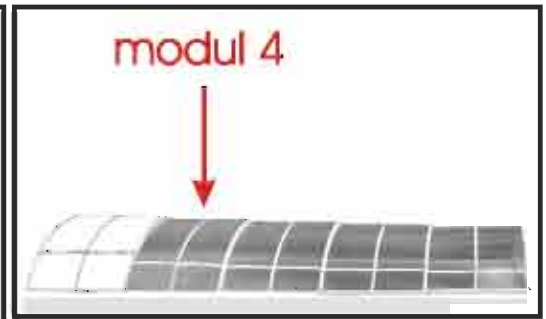
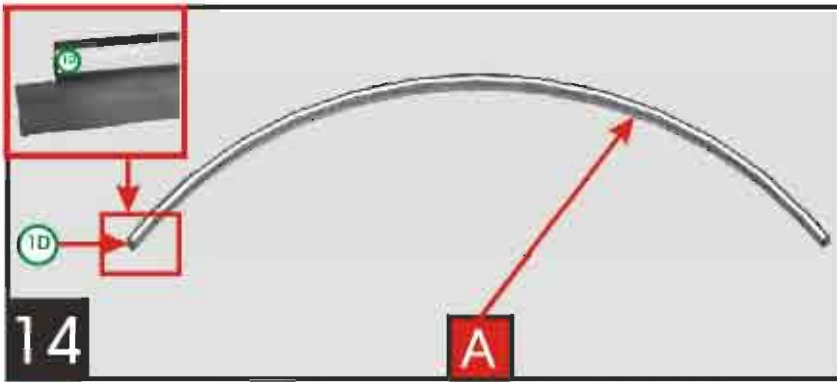

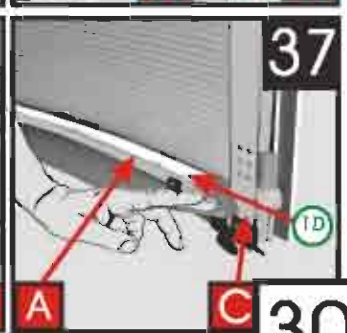
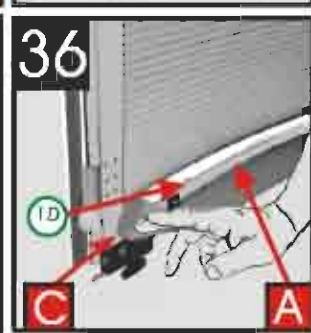
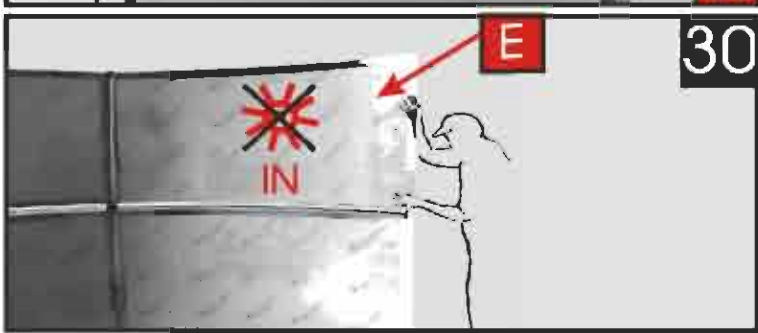
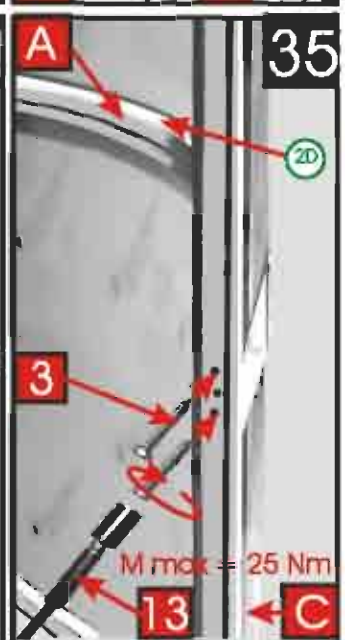
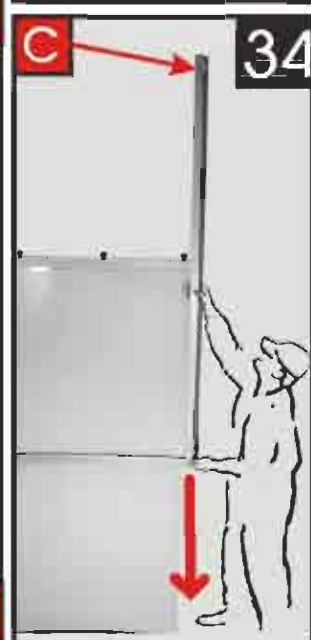
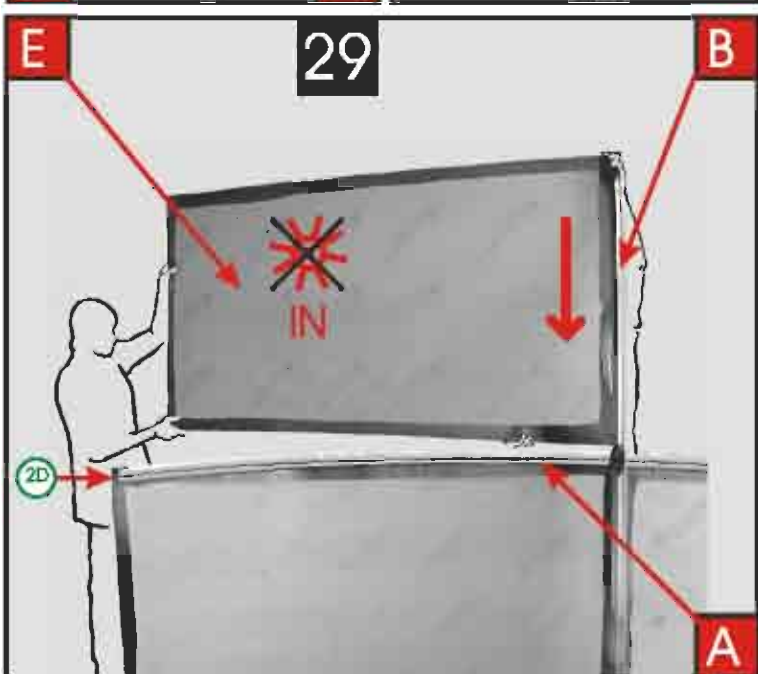
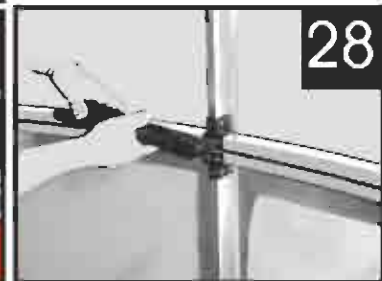
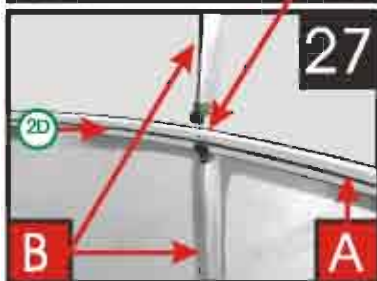
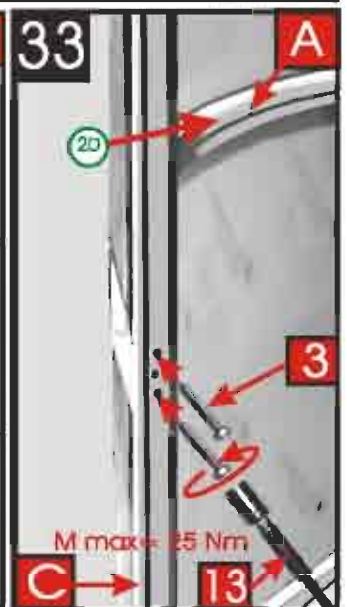
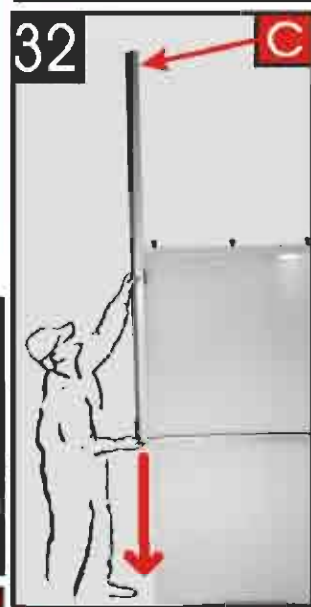
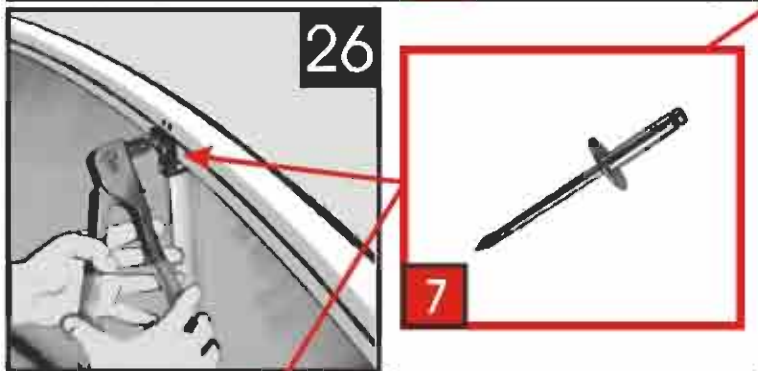
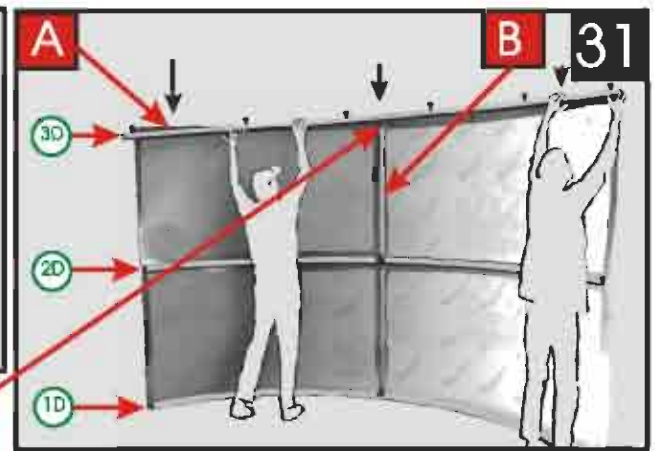
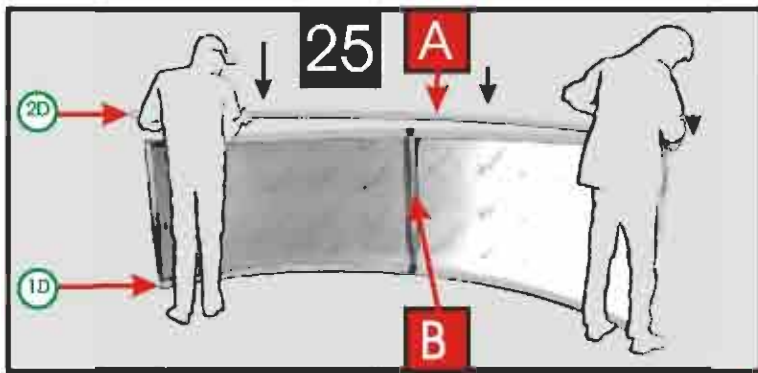

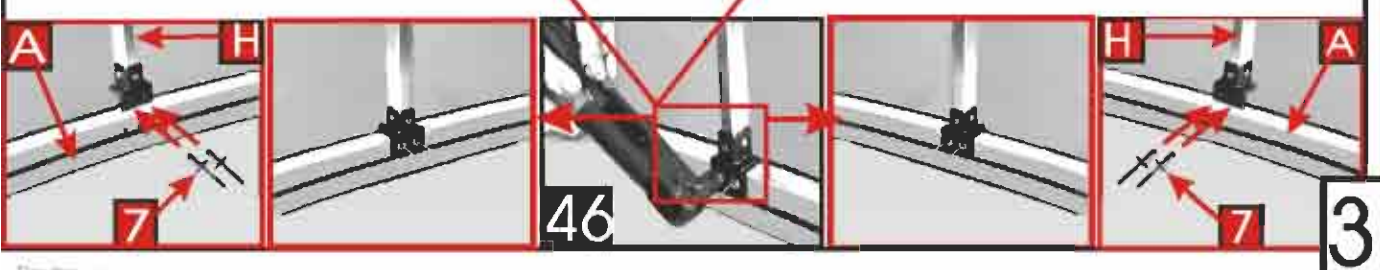
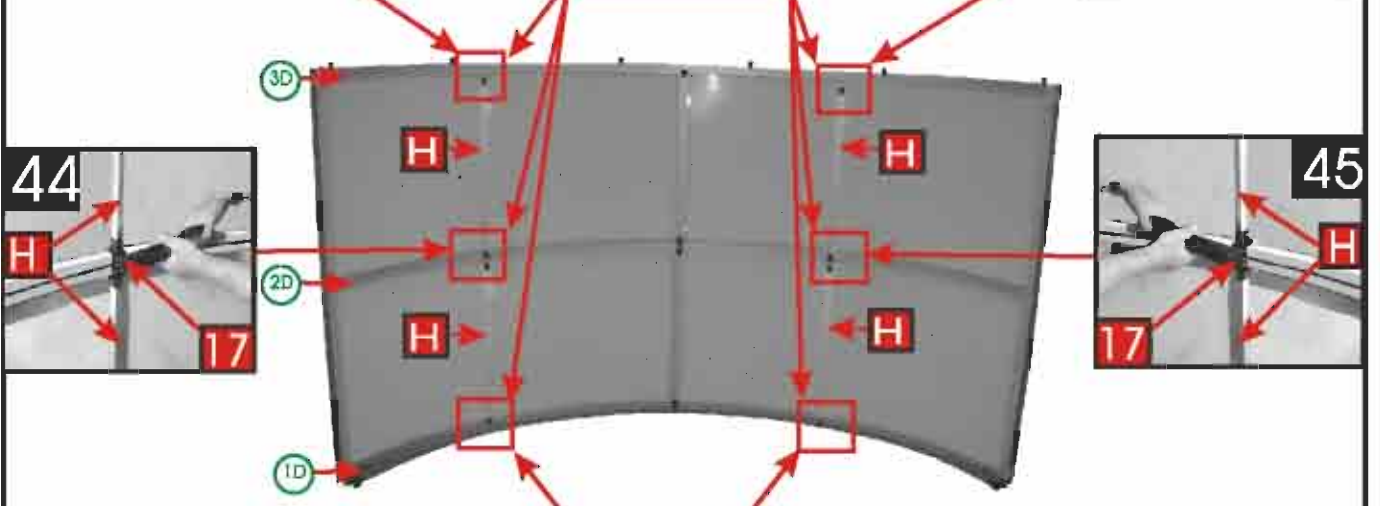
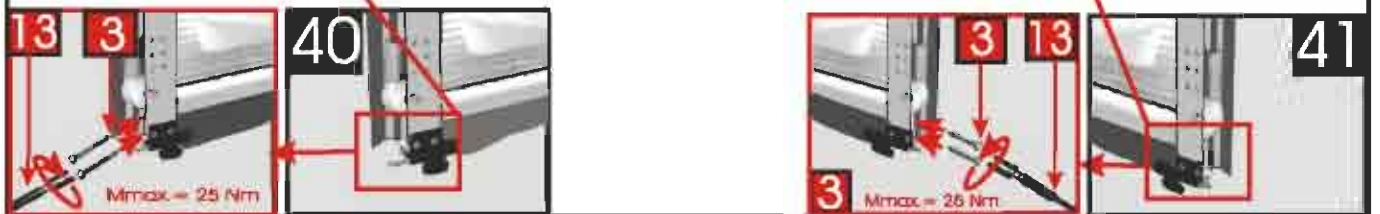



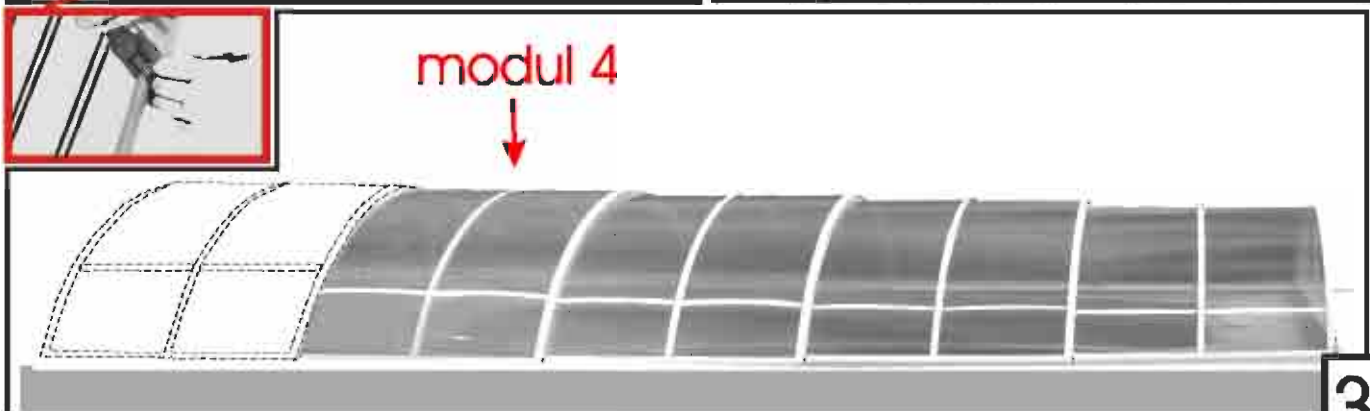
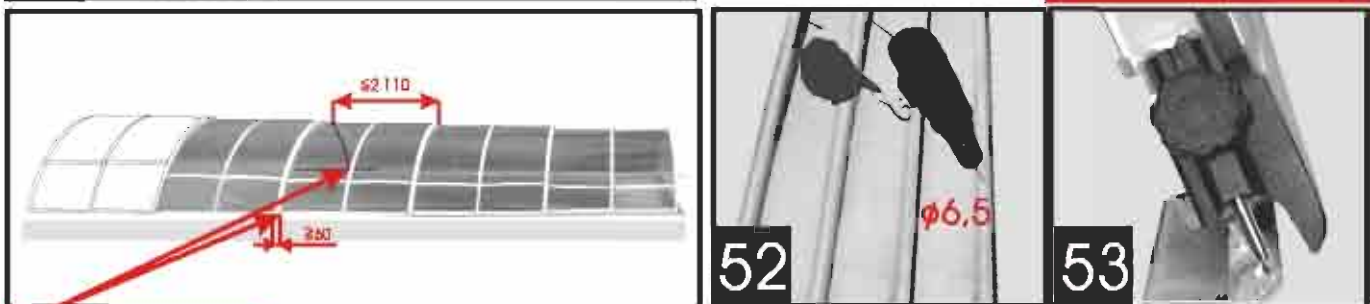
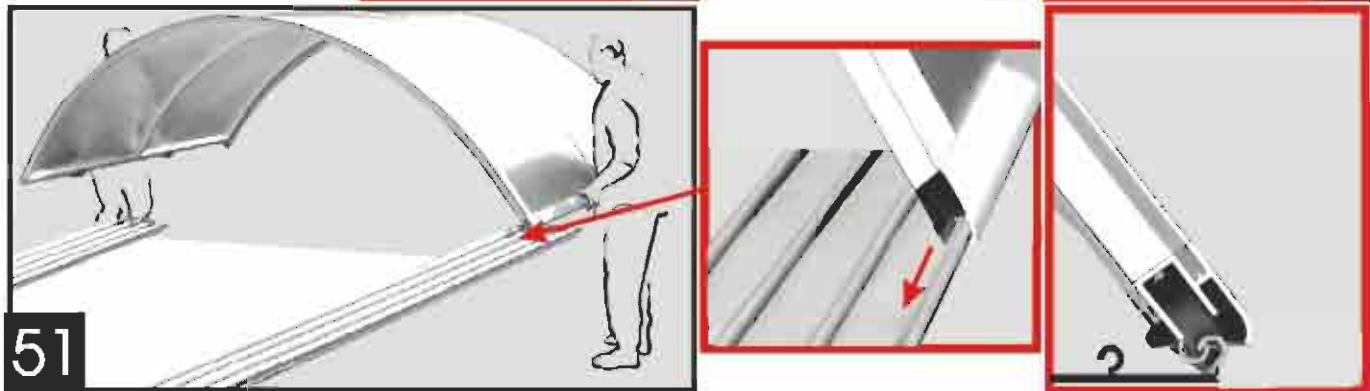
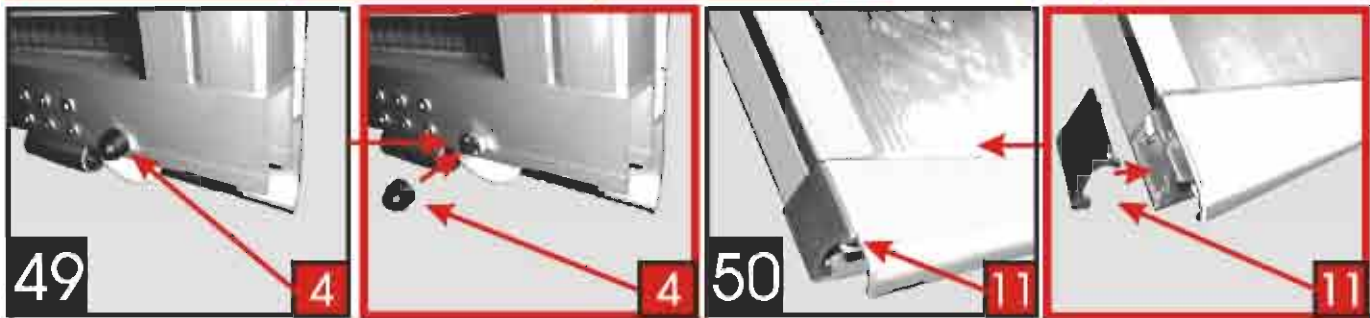
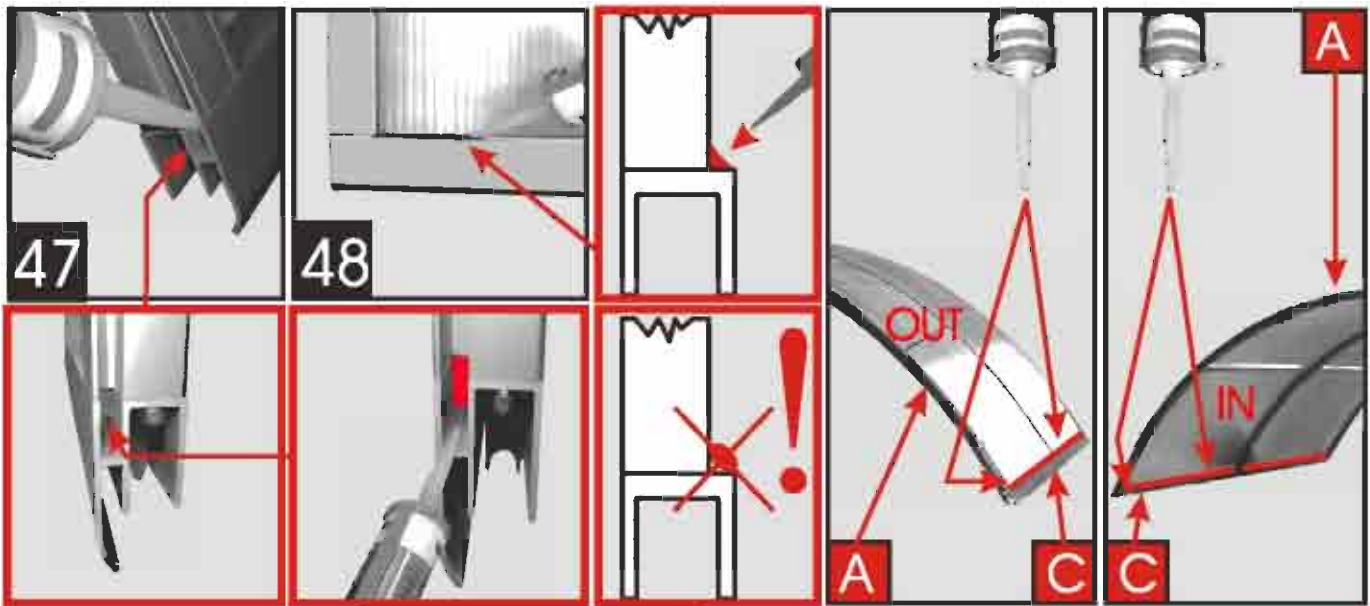

typ KLASIK C  
modul 5

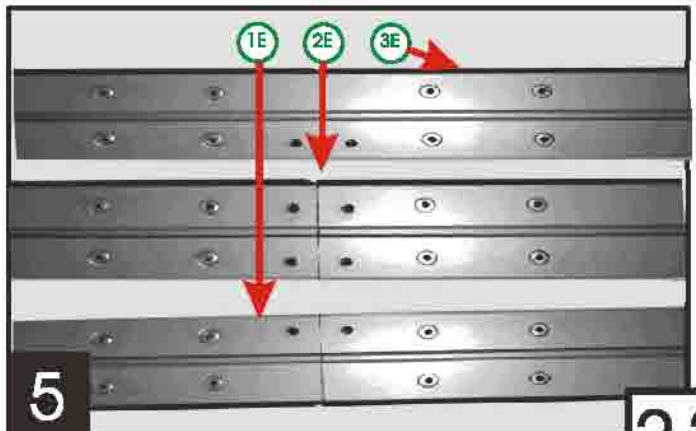
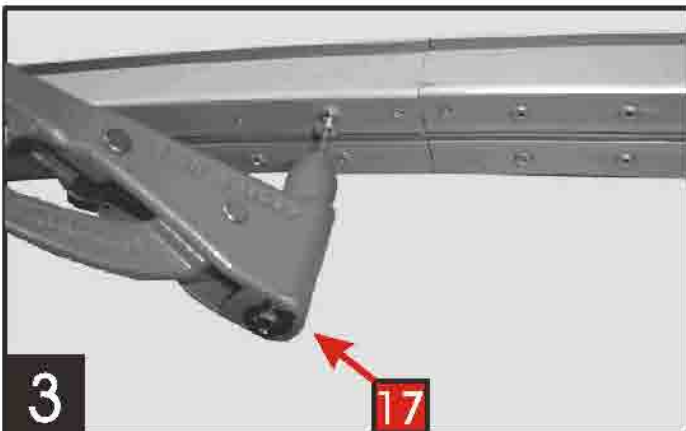
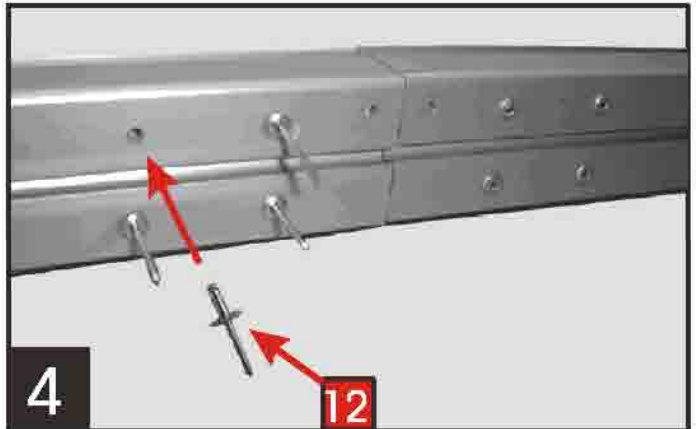
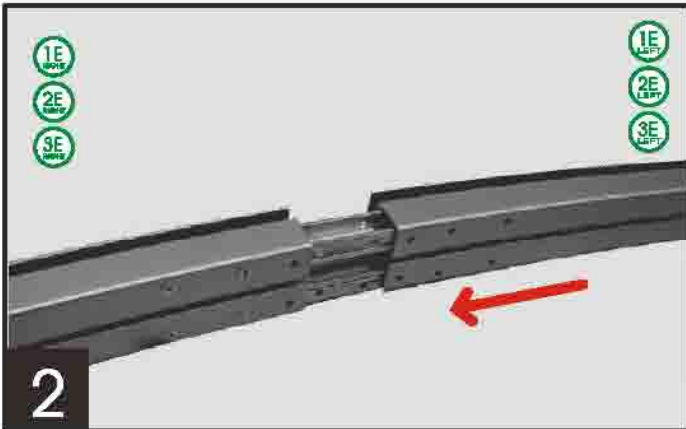
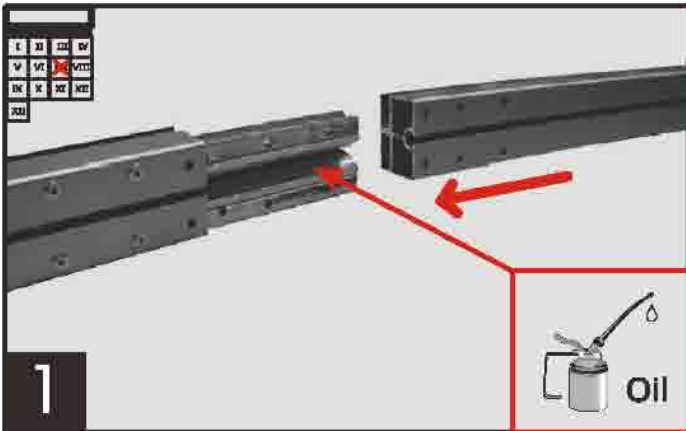
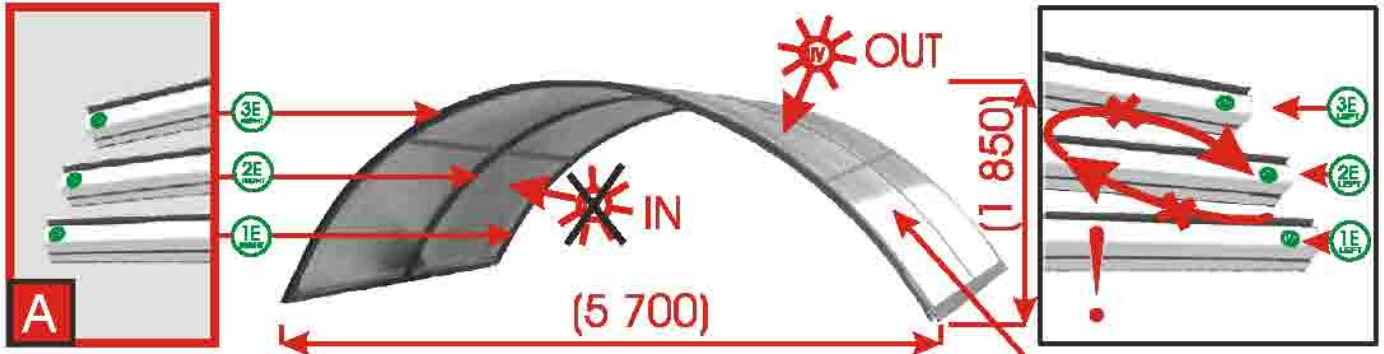

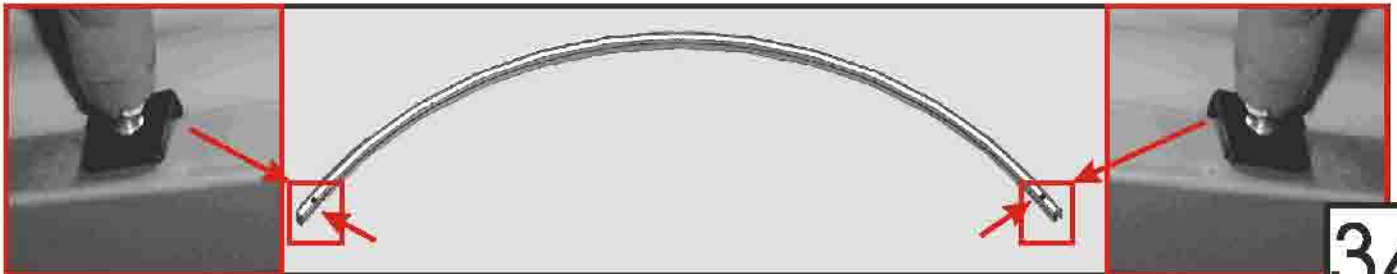
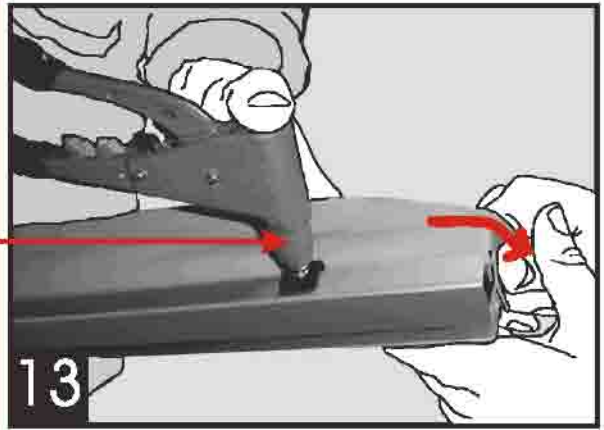
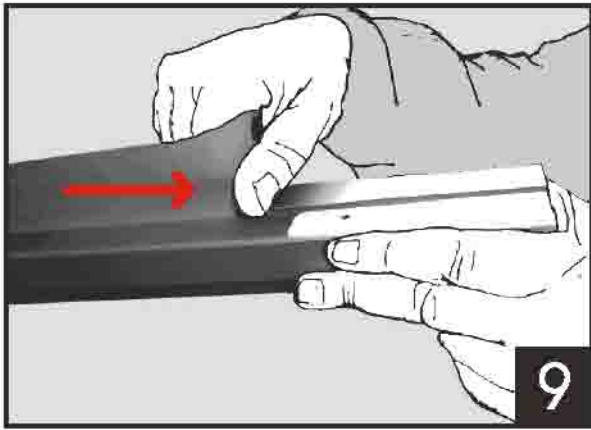
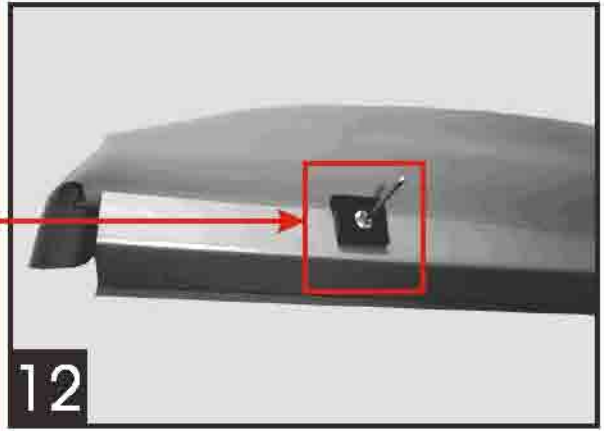
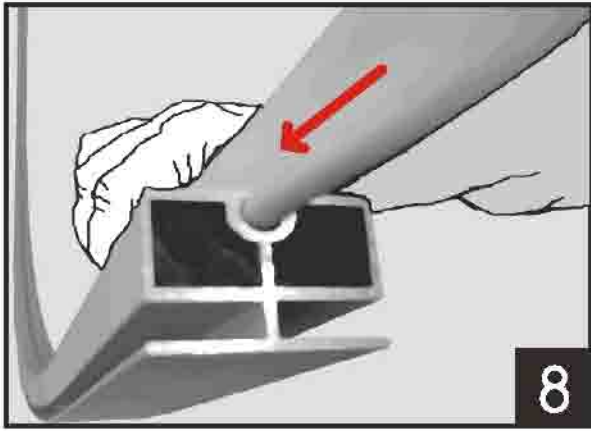
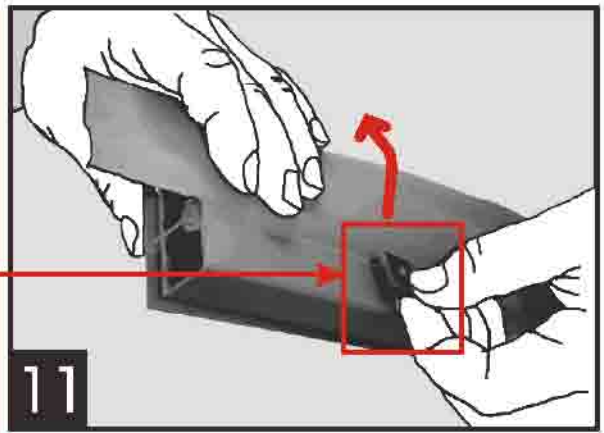
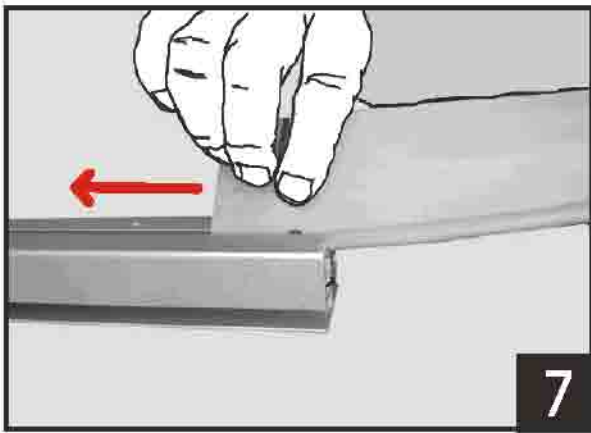
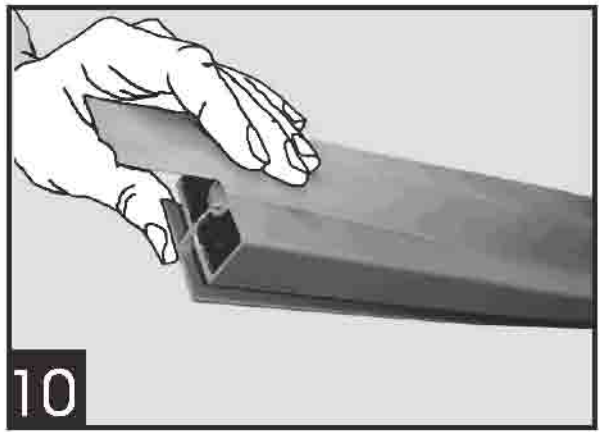
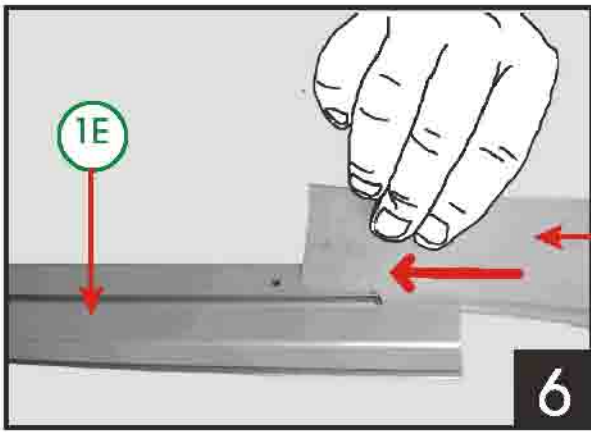

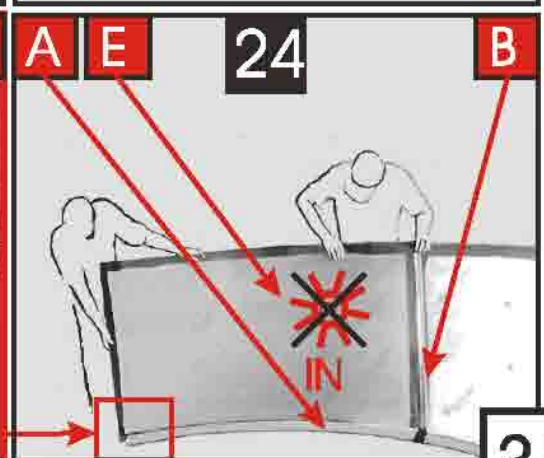
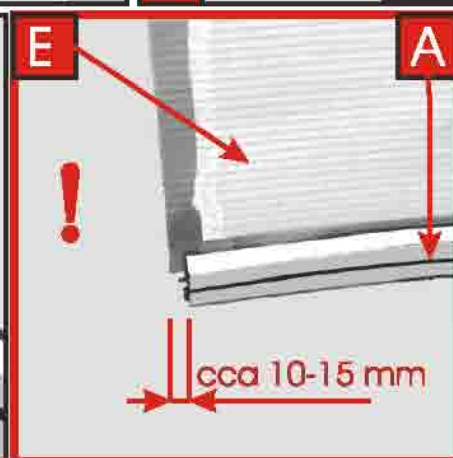
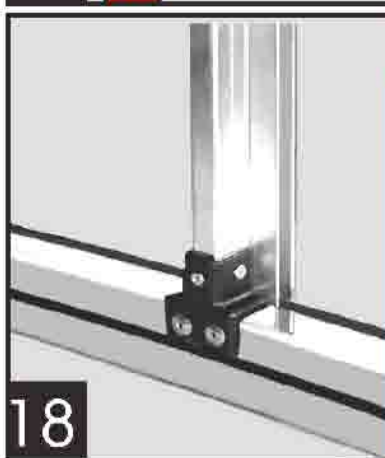
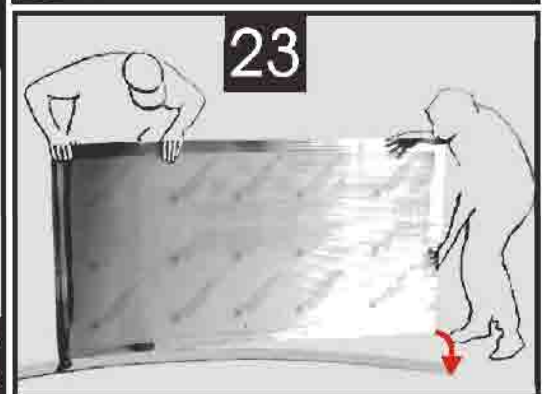
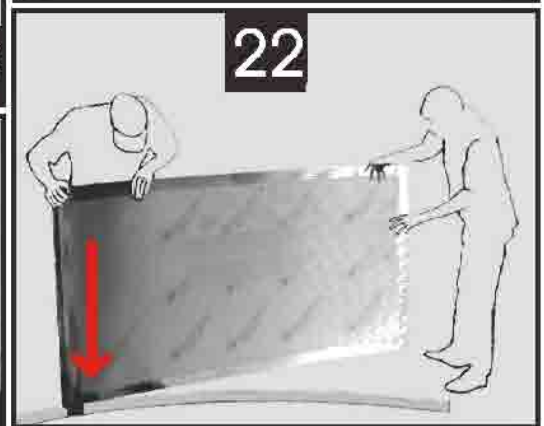
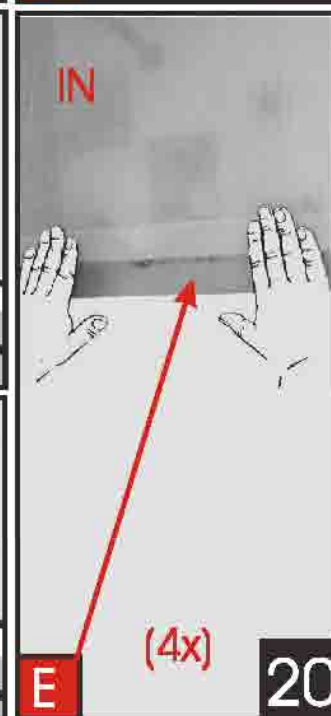
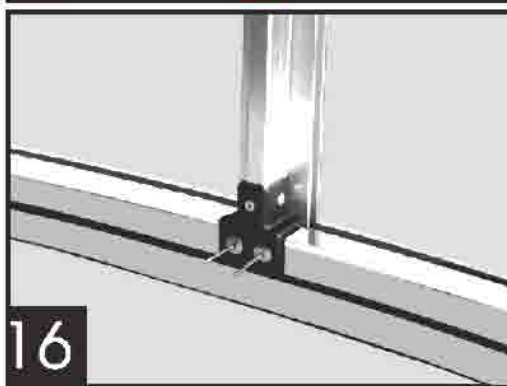
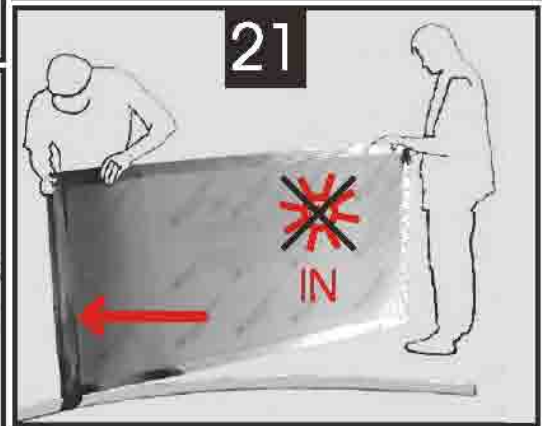
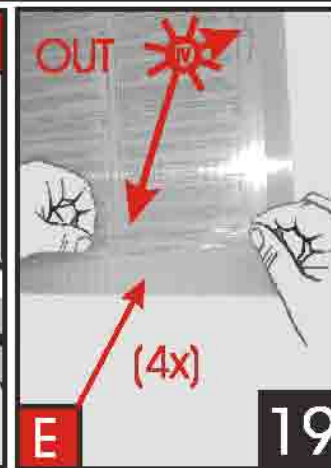
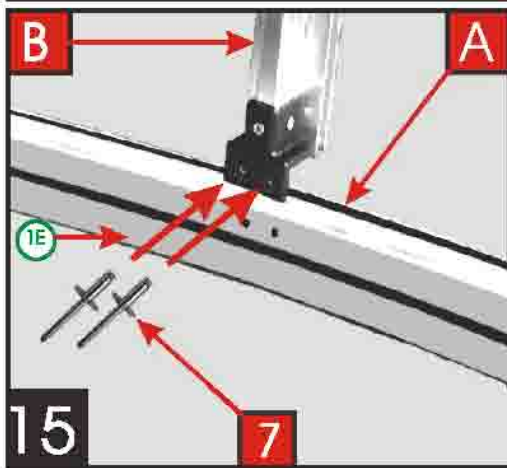
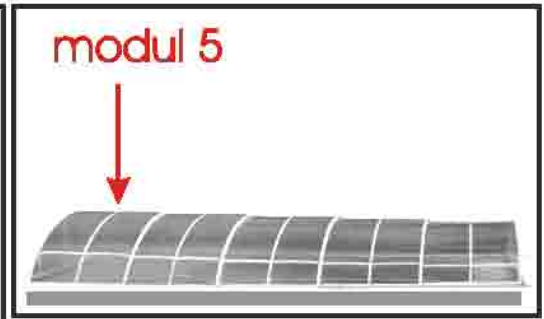
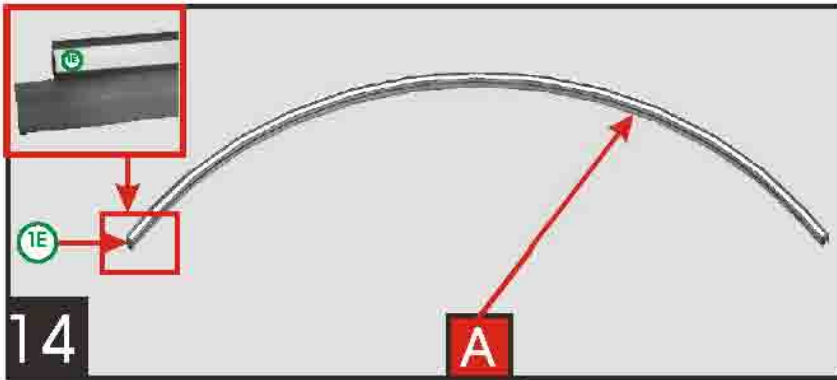

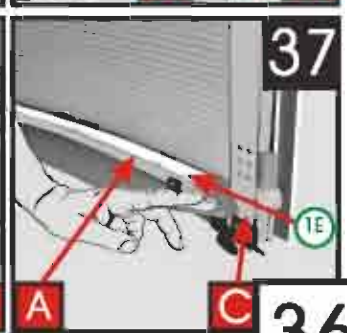
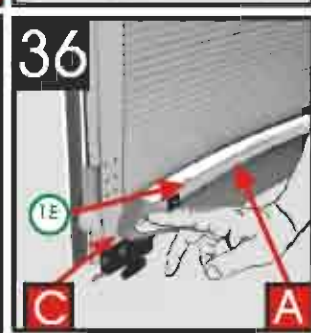
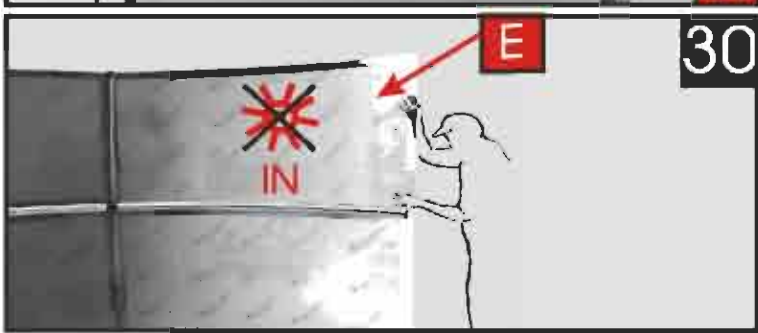
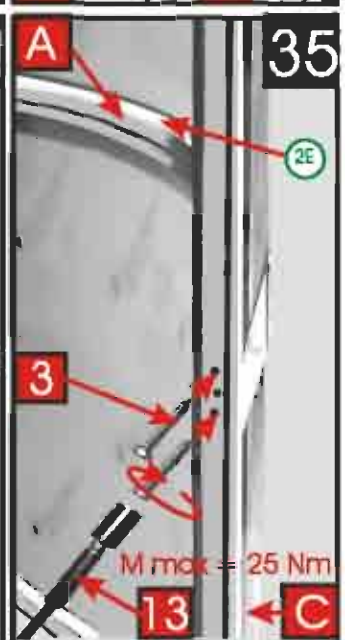
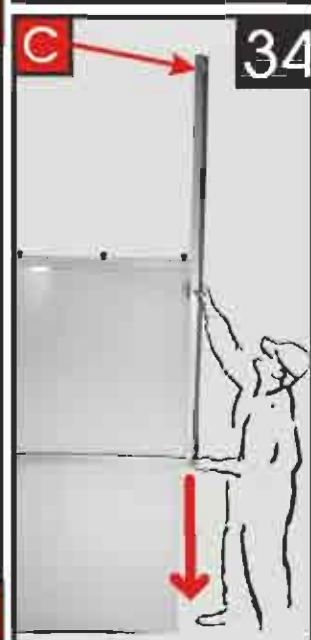
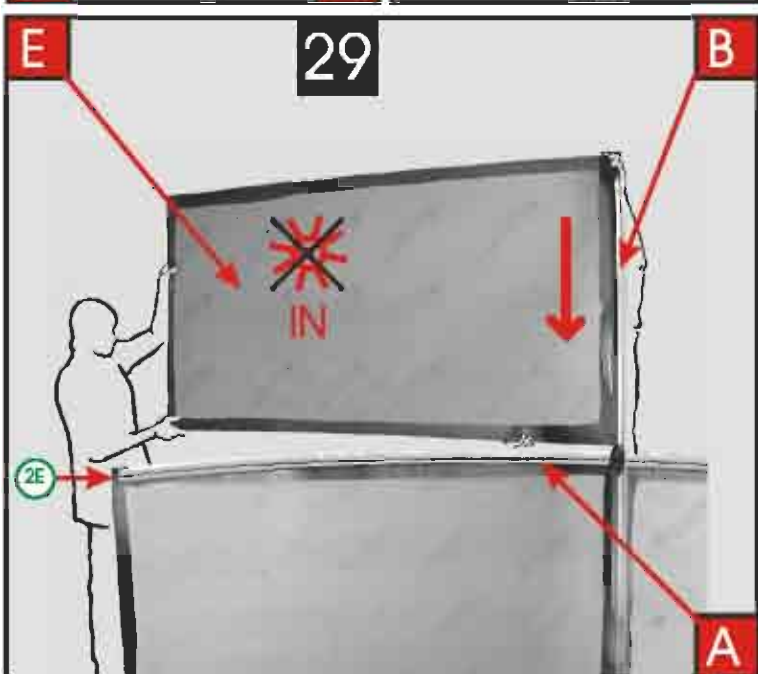
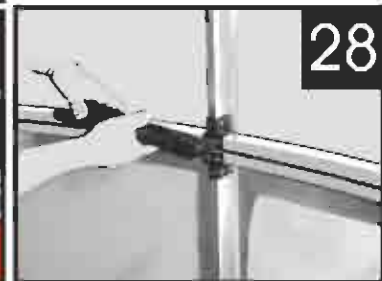
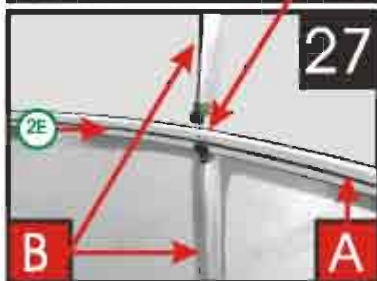
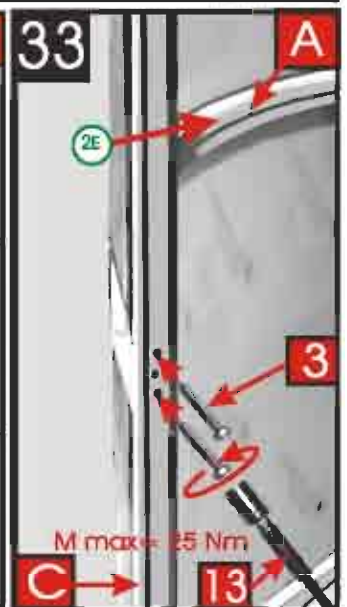
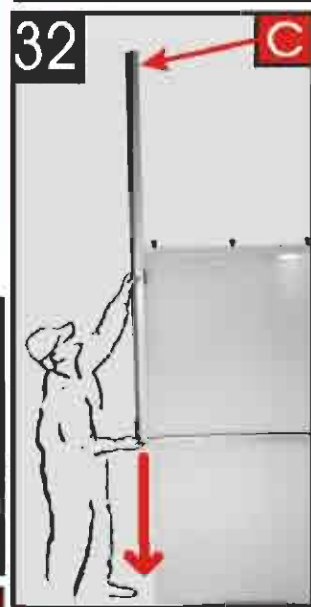
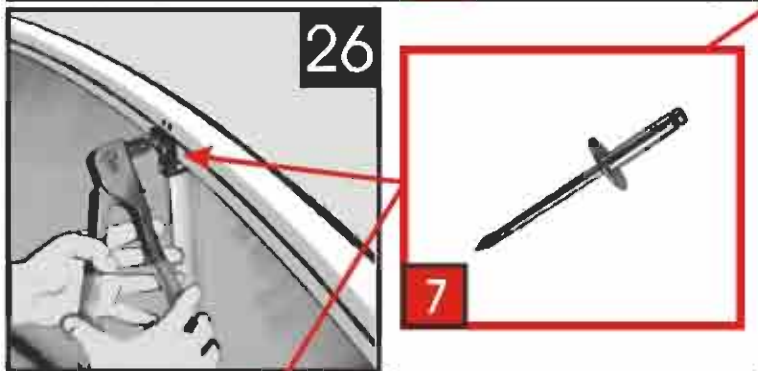
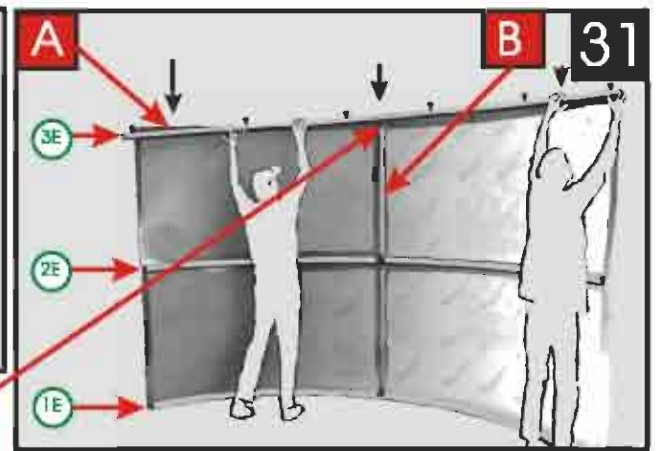
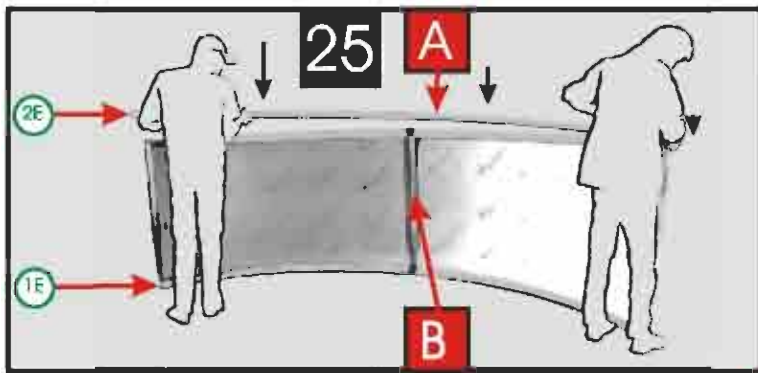

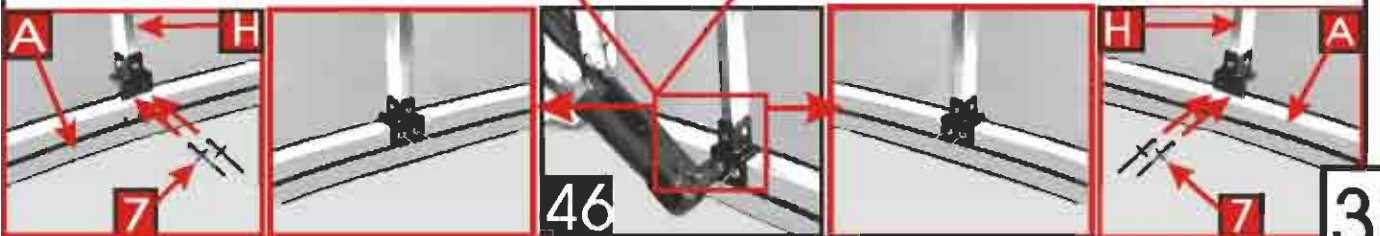
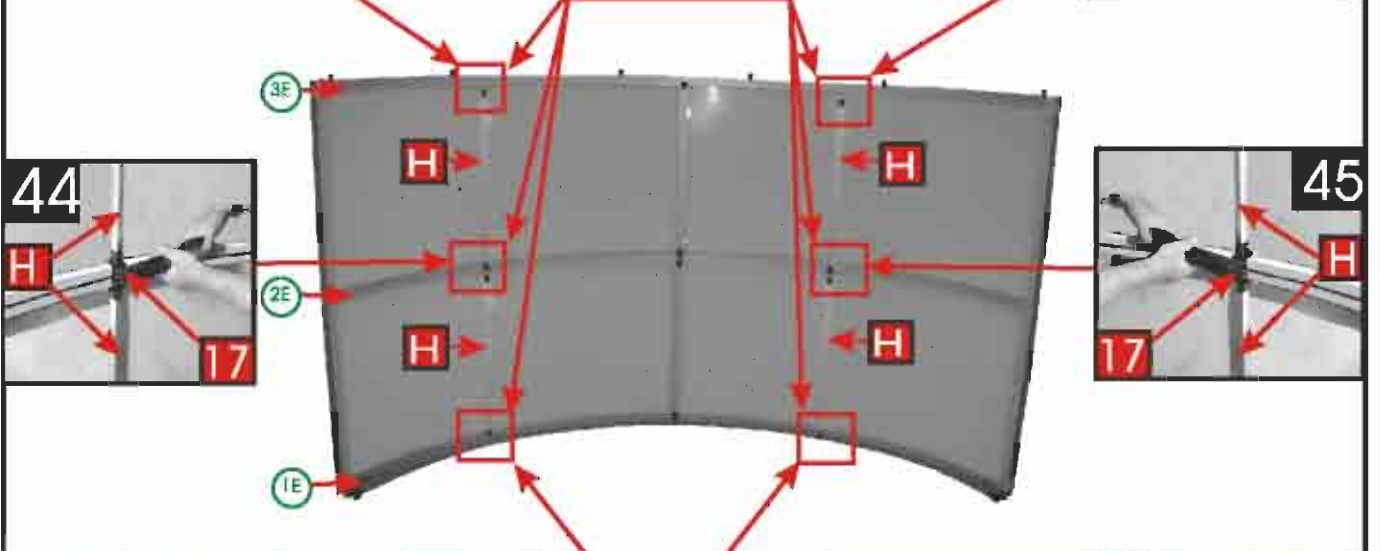
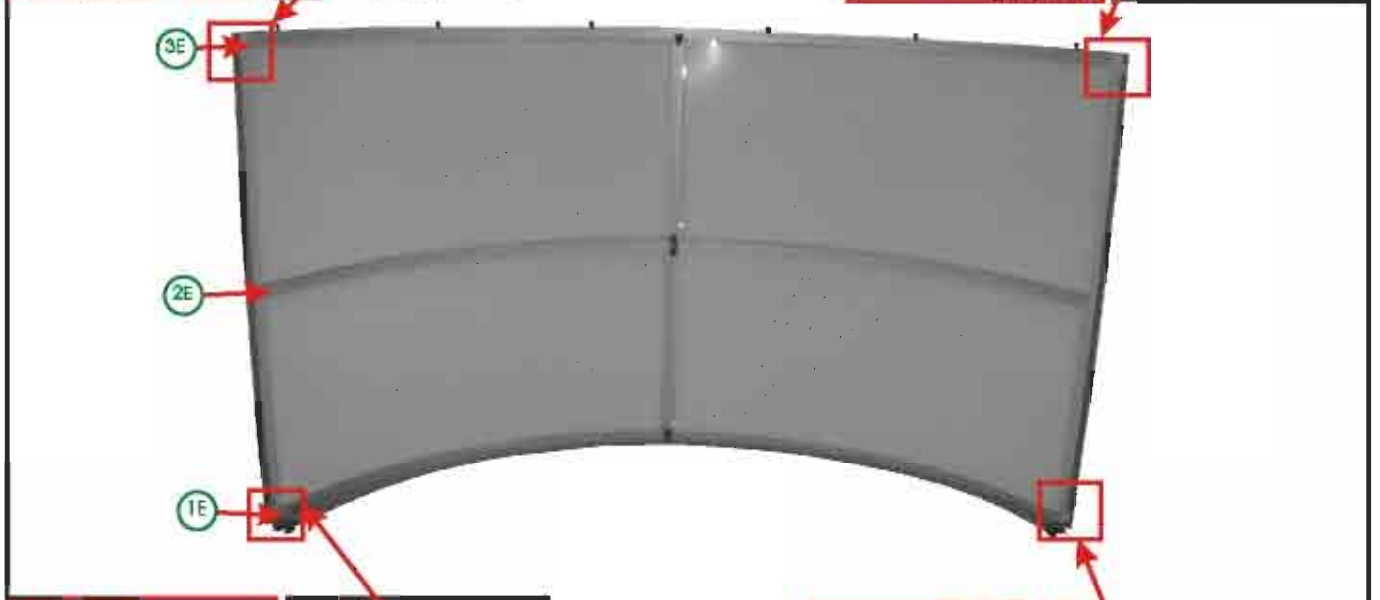

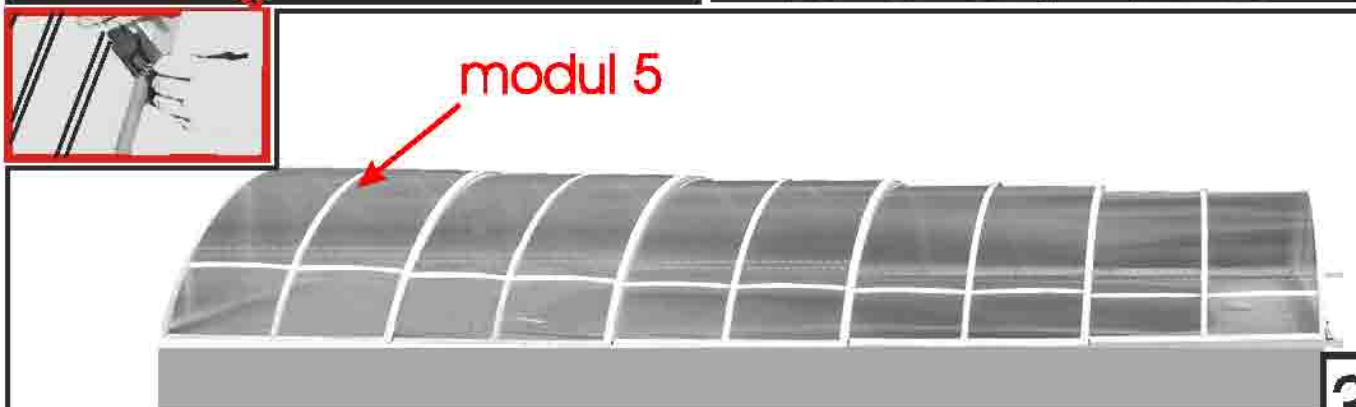
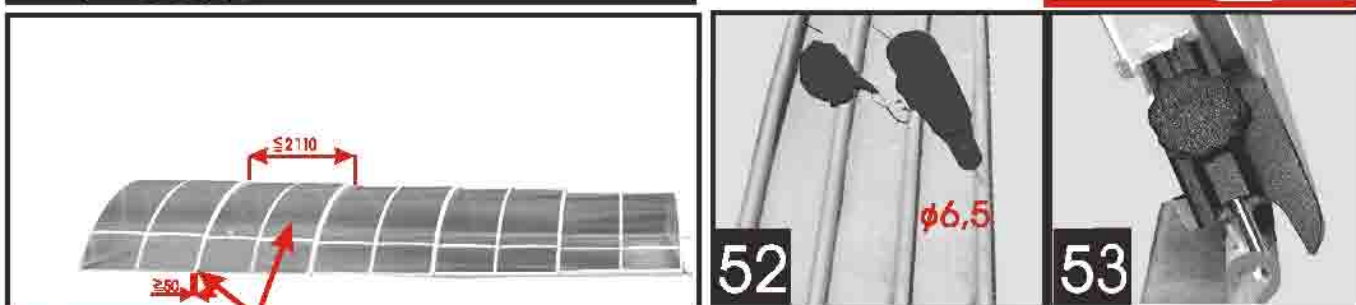
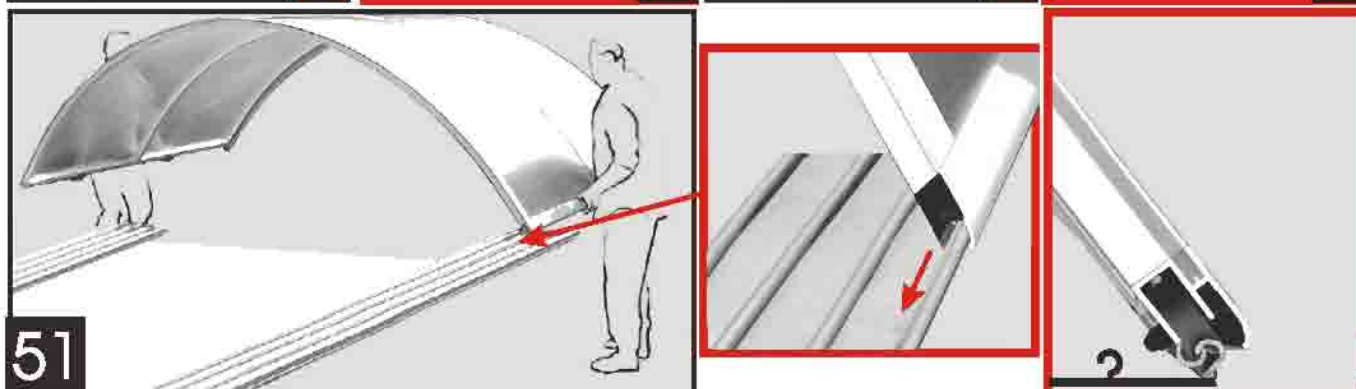
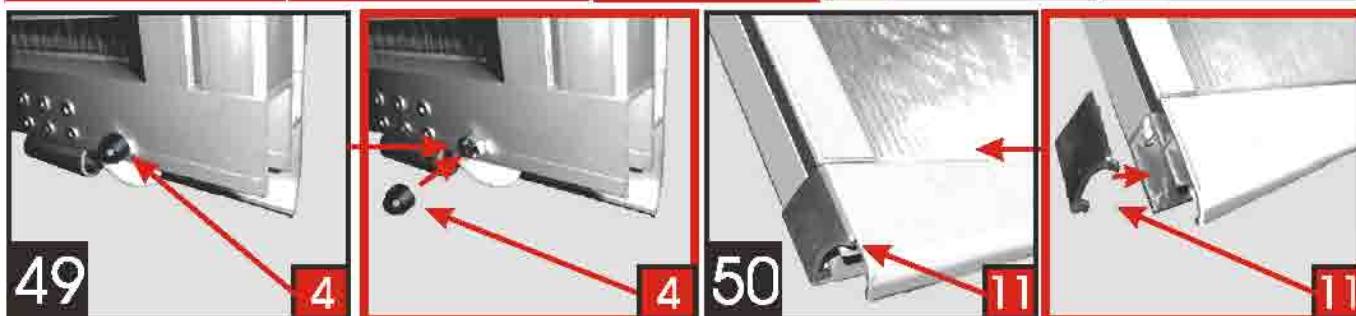
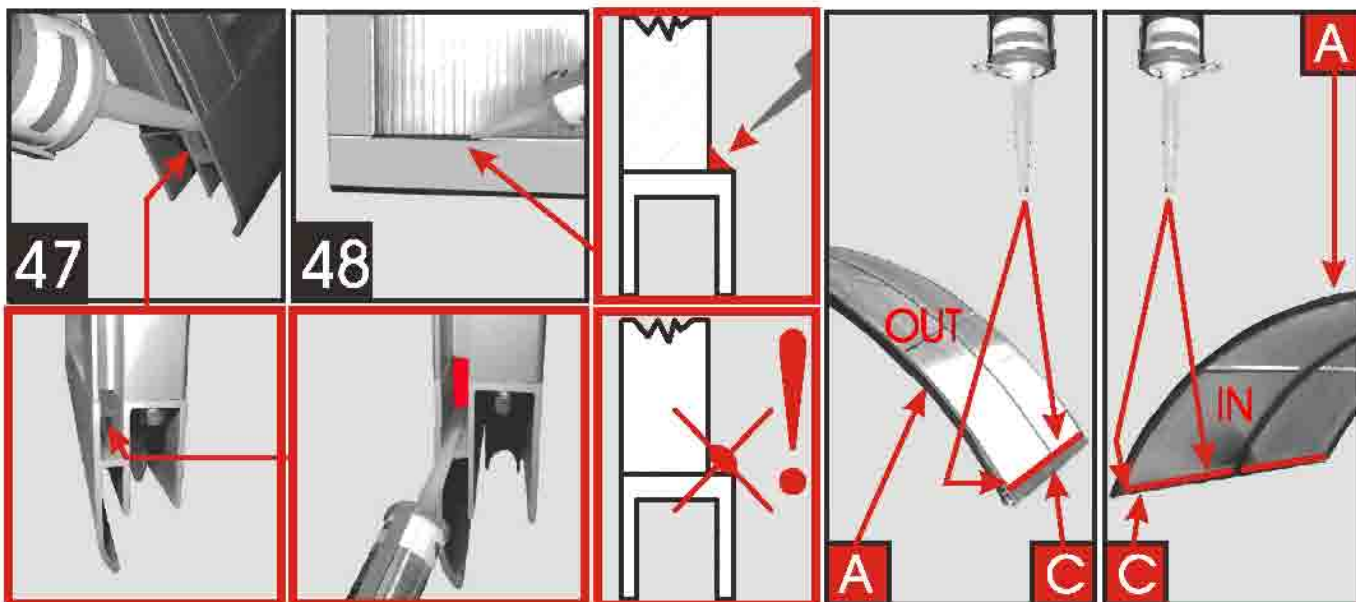

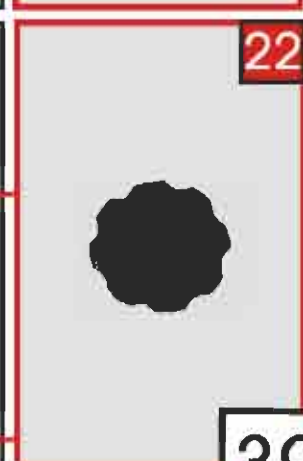
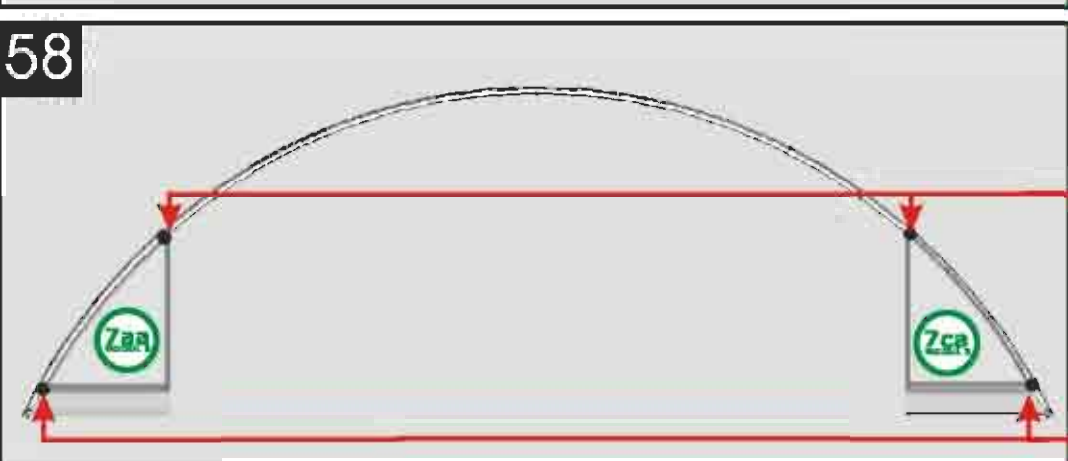
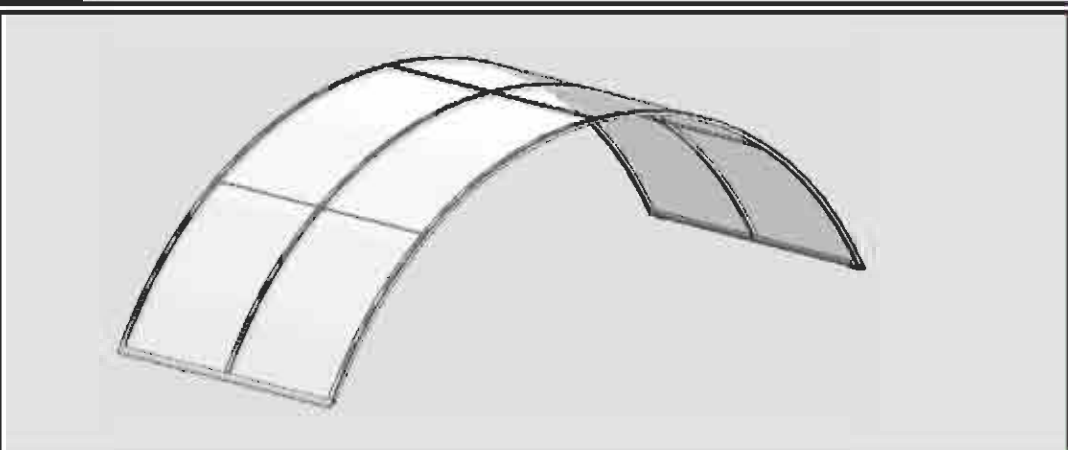
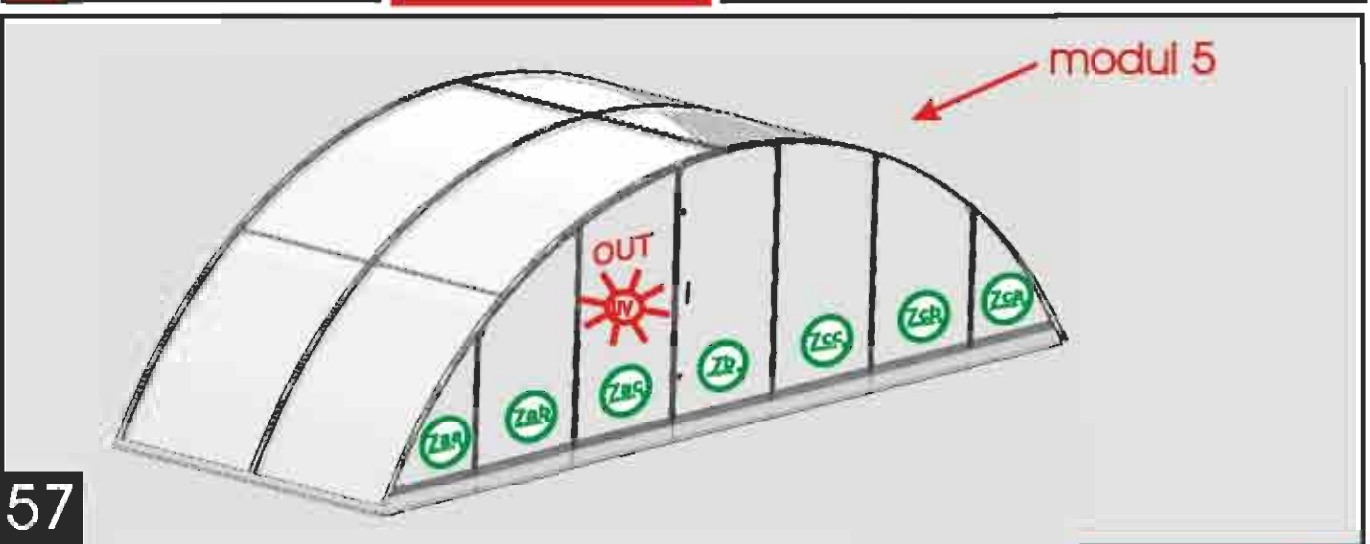
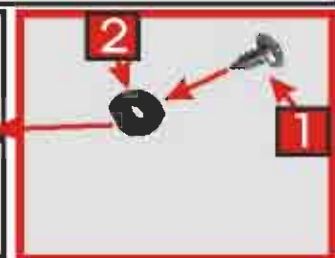
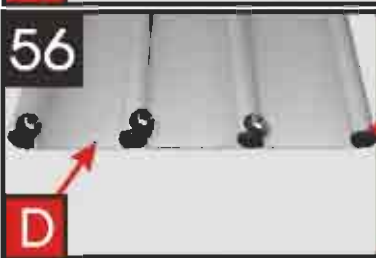
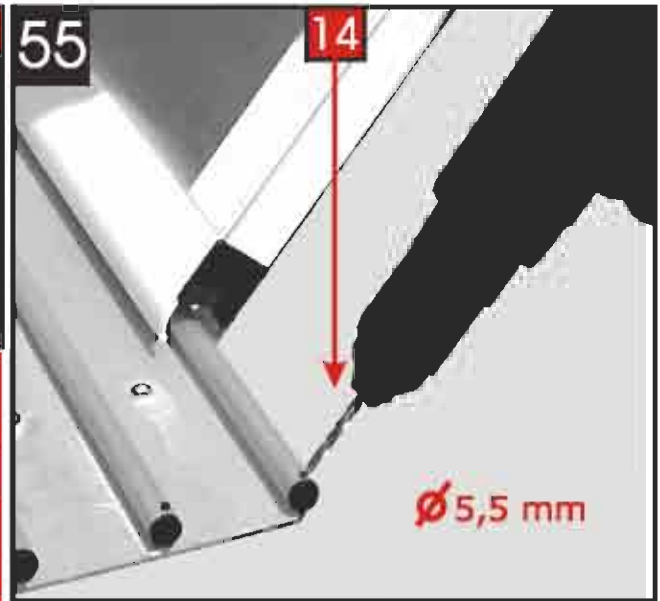
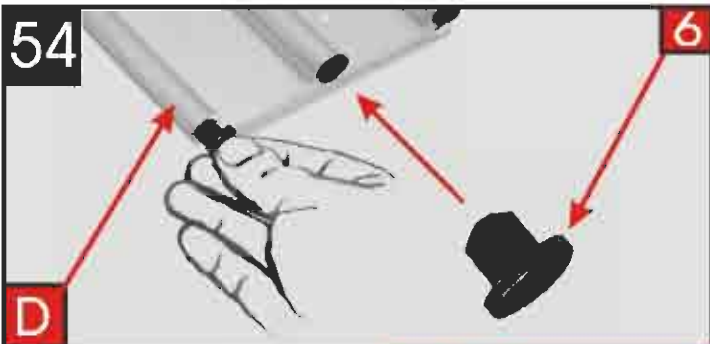



59

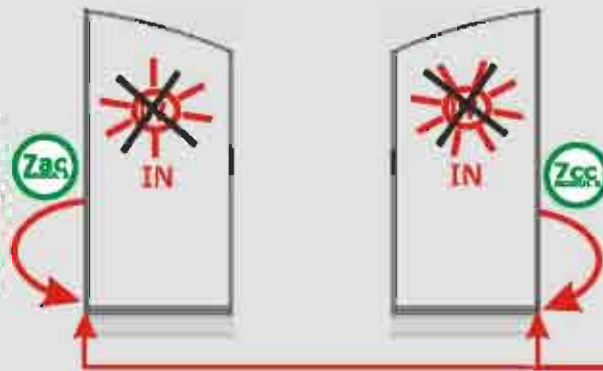

18

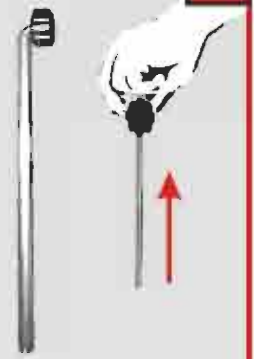

60

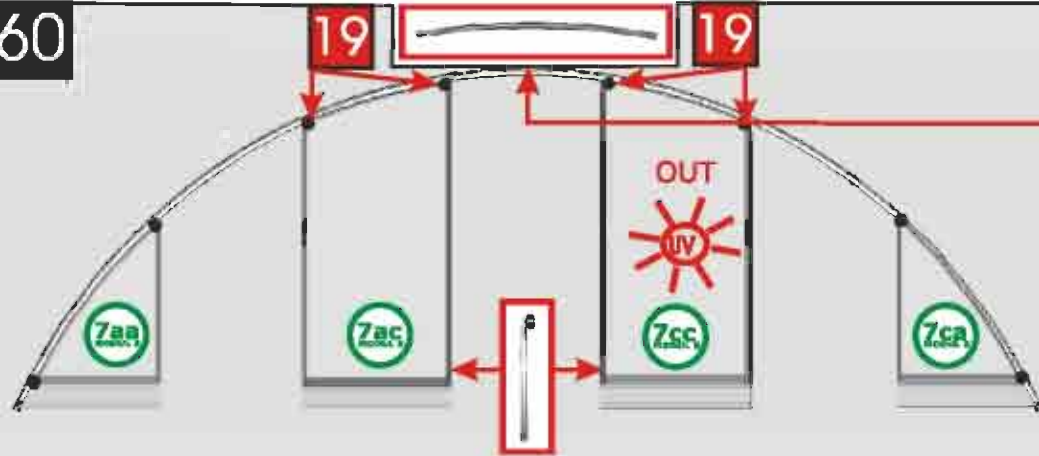

21



61

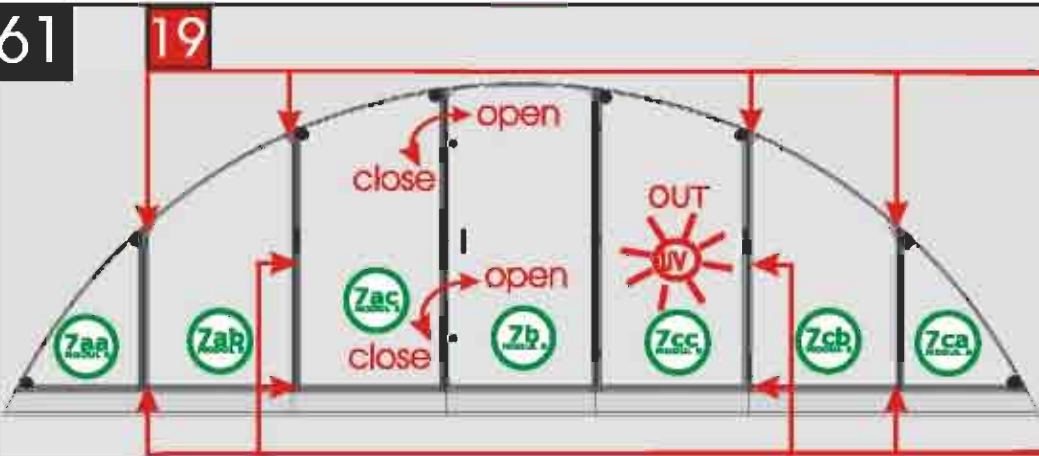

19



Nmax = 25Nm

62

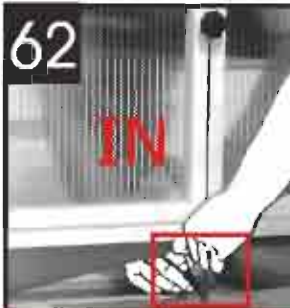

63

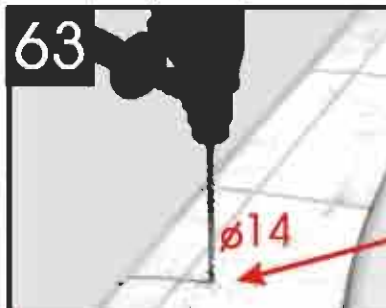

10



13

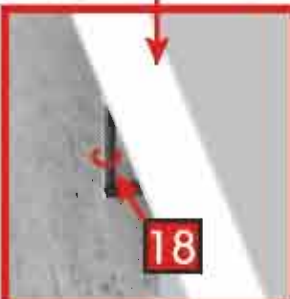

64



40

